



Friends

42614



Q LEGO® Builder



Get excited about our new packaging!

We're switching from plastic to paper-based packaging. That's why you might find a mix of paper and plastic in our boxes!

Nos nouveaux emballages vous emballeront !

Nous passons des emballages en plastique aux emballages à base de papier. C'est pourquoi vous pourriez trouver un mélange de papier et de plastique dans nos boîtes !

¡Te presentamos nuestros nuevos empaques!

Estamos sustituyendo las bolsas de plástico por bolsas con base de papel. ¡Por eso, puedes encontrar una mezcla de papel y de plástico en nuestras cajas!

[LEGO.com/sustainable-packaging](https://www.lego.com/sustainable-packaging)

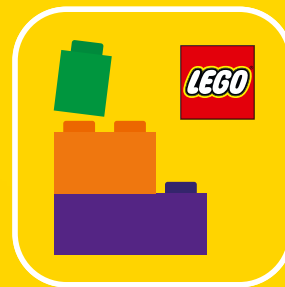

BUILDER



Apple and the Apple logo are trademarks of Apple Inc., registered in the U.S. and other countries and regions. App Store is a service mark of Apple Inc. Google Play and the Google Play logo are trademarks of Google LLC. Tencent and the Tencent logo are trademarks of Tencent Inc.

LEGO.com/devicecheck

EN Ask parents' permission before going online | DE Eltern um Erlaubnis bitten, bevor du online gehst | FR Demande l'autorisation d'un parent avant d'aller en ligne | IT Chiedi il permesso ai tuoi genitori prima di andare online | ES Pídeles permiso a tus papás antes de conectarte a Internet | PT Peça autorização aos pais antes de acederes online | ZH 上网前应先征得父母的同意 | PL Poproś rodziców o zgodę, zanim wejdiesz do Internetu | CS Než půjdeš na internet, požádej rodiče o svolení | SK Skôr než pôjdeš na internet, vypýtaj si povolenie od rodičov | HU Kérj szülői engedélyt, mielőtt online csatlakoznál! | RO Cere permisiunea părinților înainte de a te conecta online | BG Поискайте разрешение от родител, преди да влезете онлайн | LV Pirms došanās tiešsaistē palūdz atļauju vecākiem | ET Enne Interneti kasutamist küsi vanematelt luba | LT Prieš prisijungdami prie interneto, atsklauskite tėvų

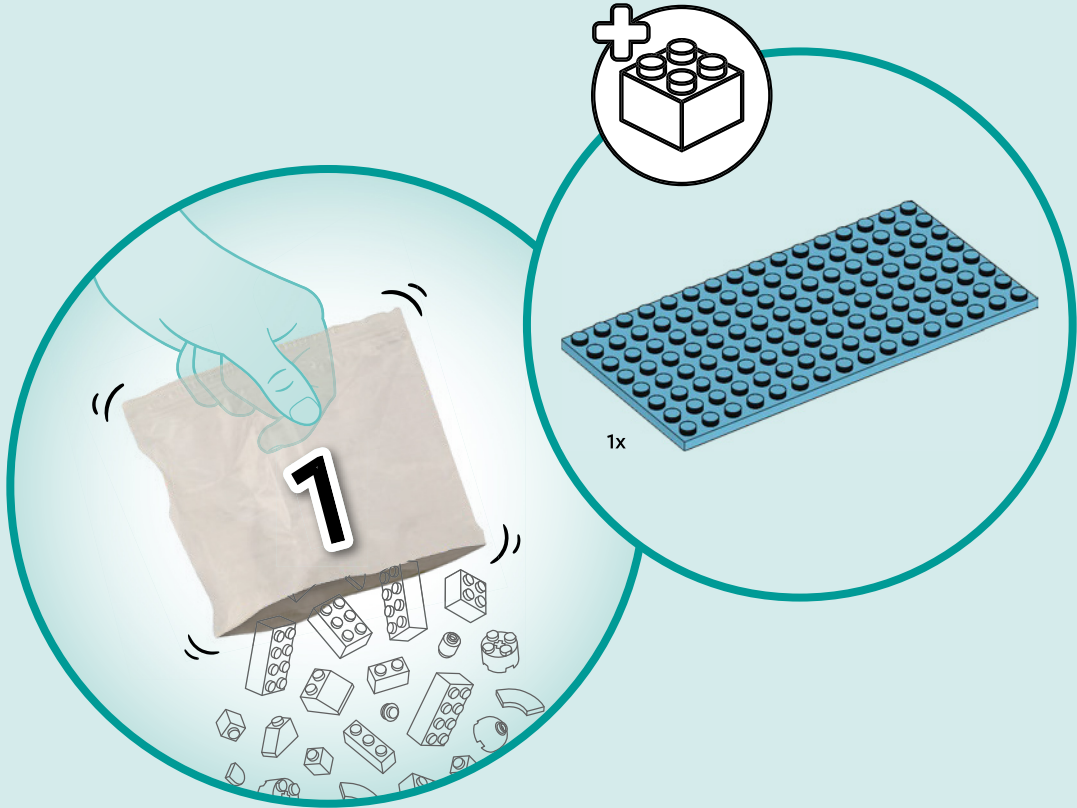

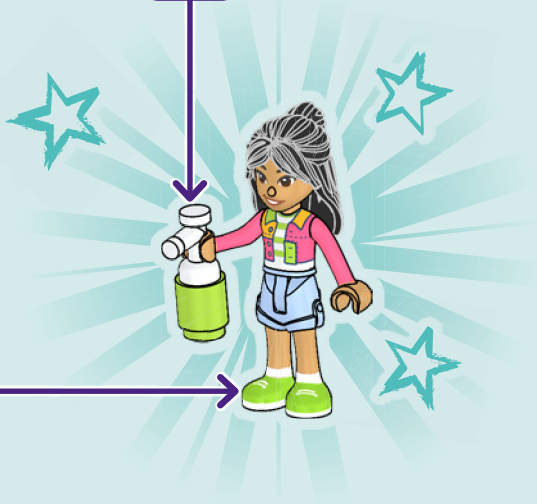
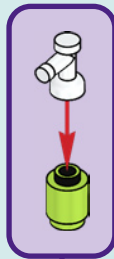
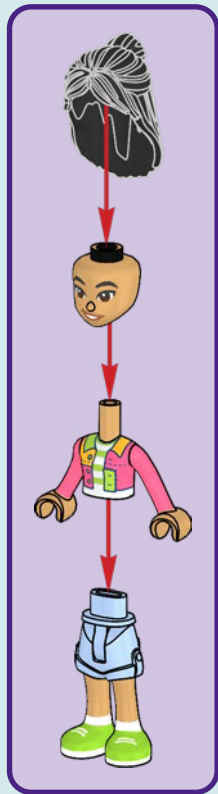

LIANN

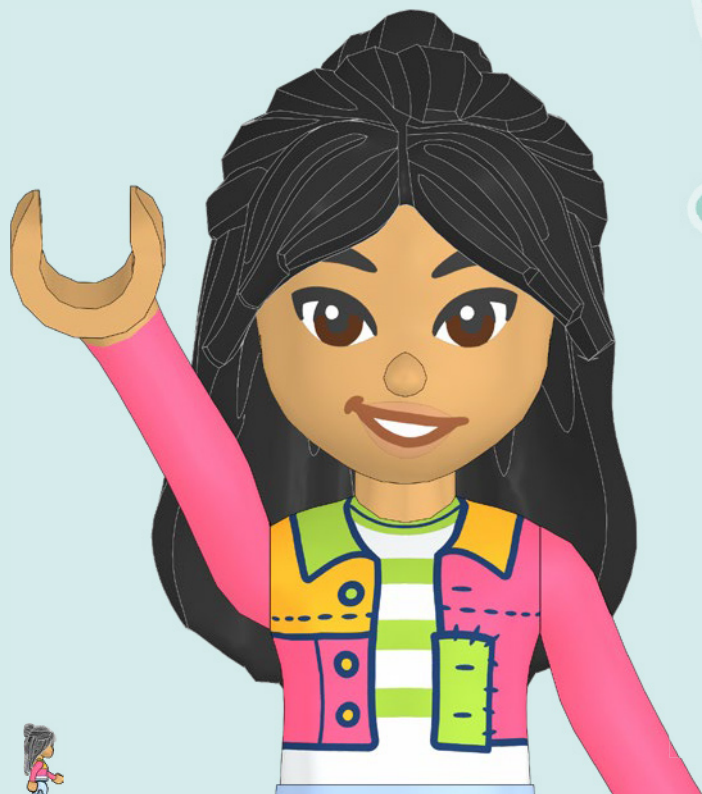



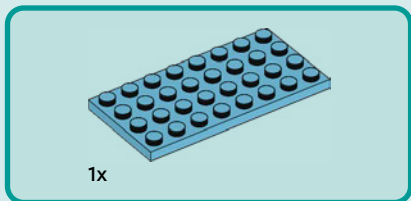
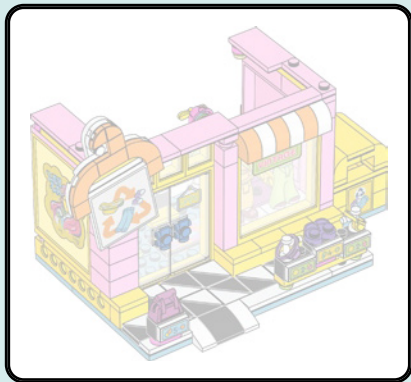

1

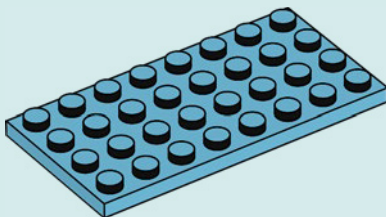

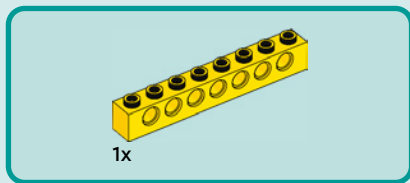

2

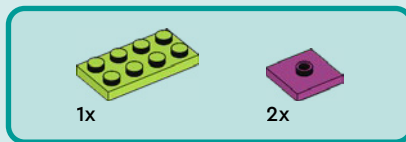
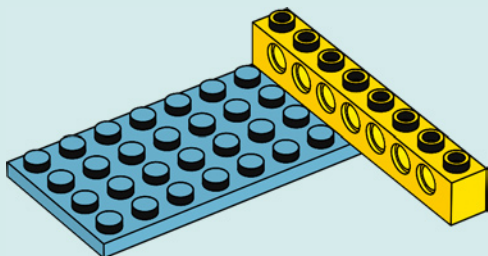

3

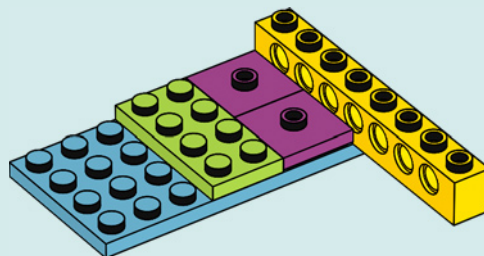

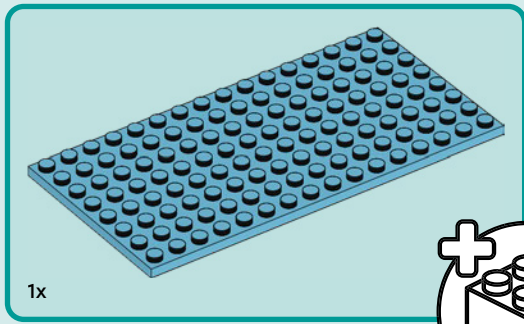

1x

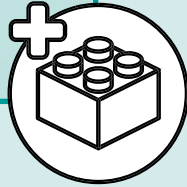

4

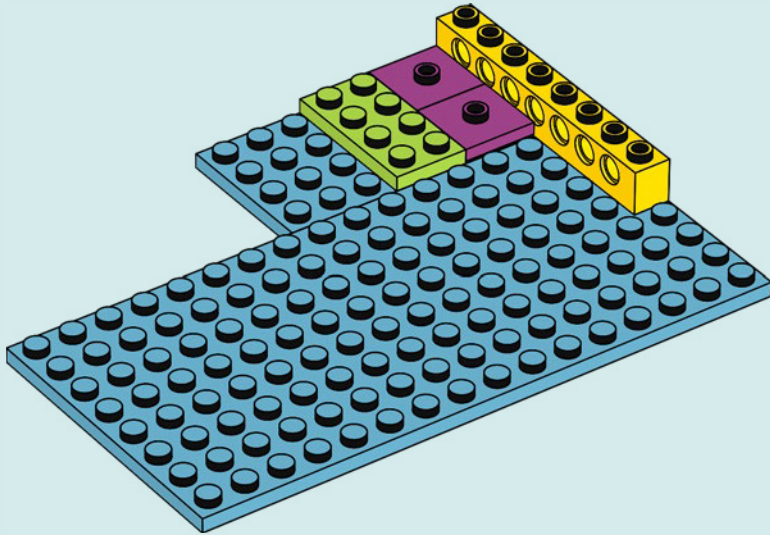

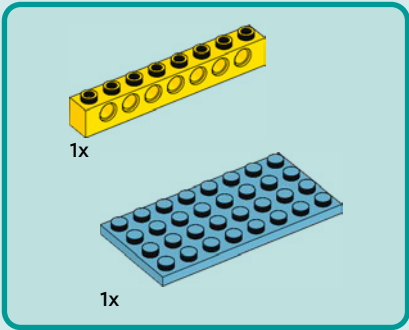

5

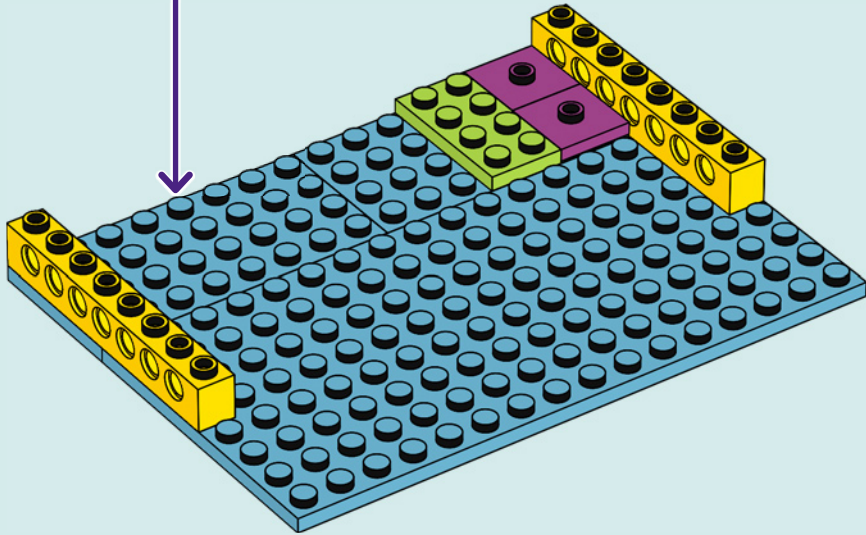
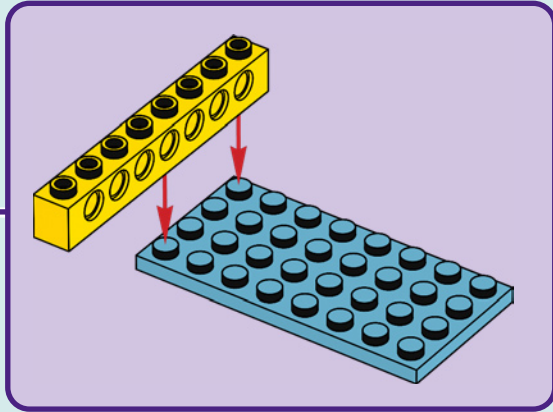

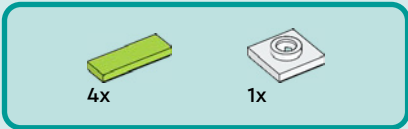

6

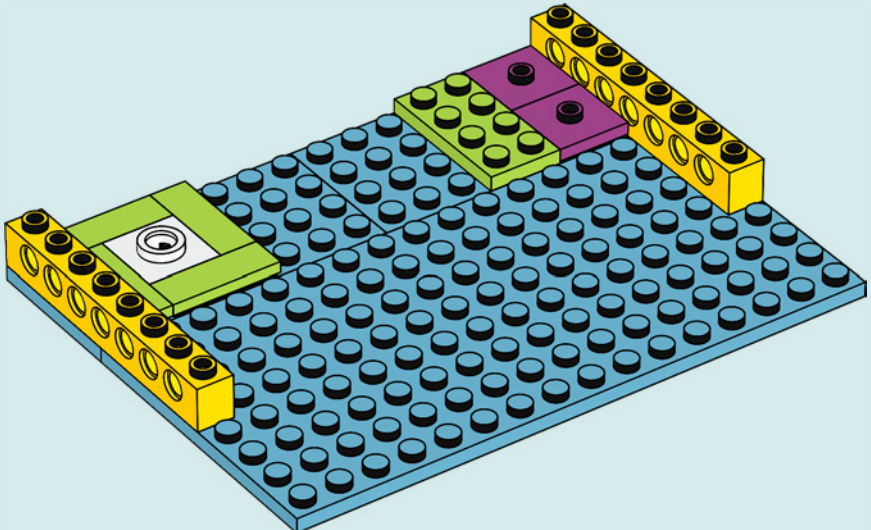



7

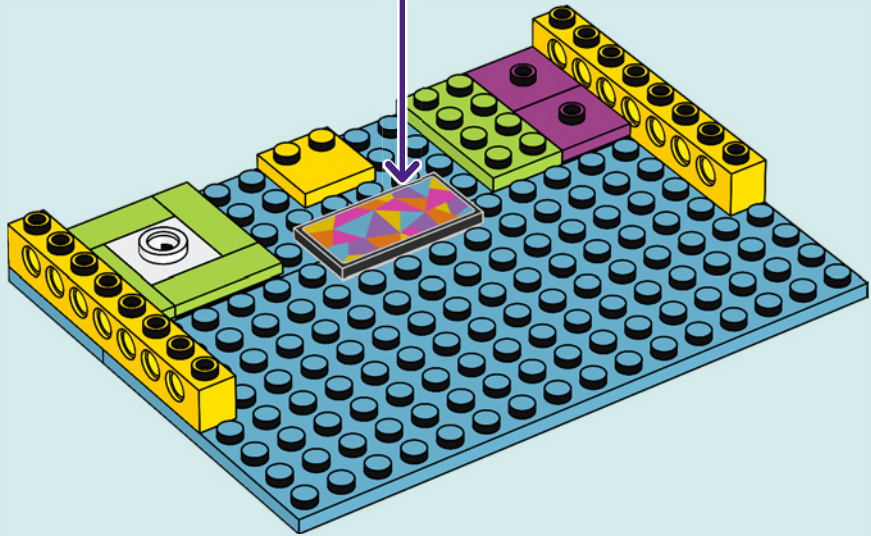
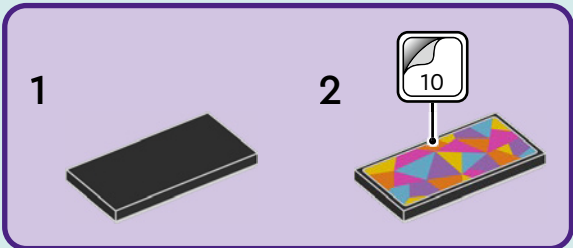



2x

8

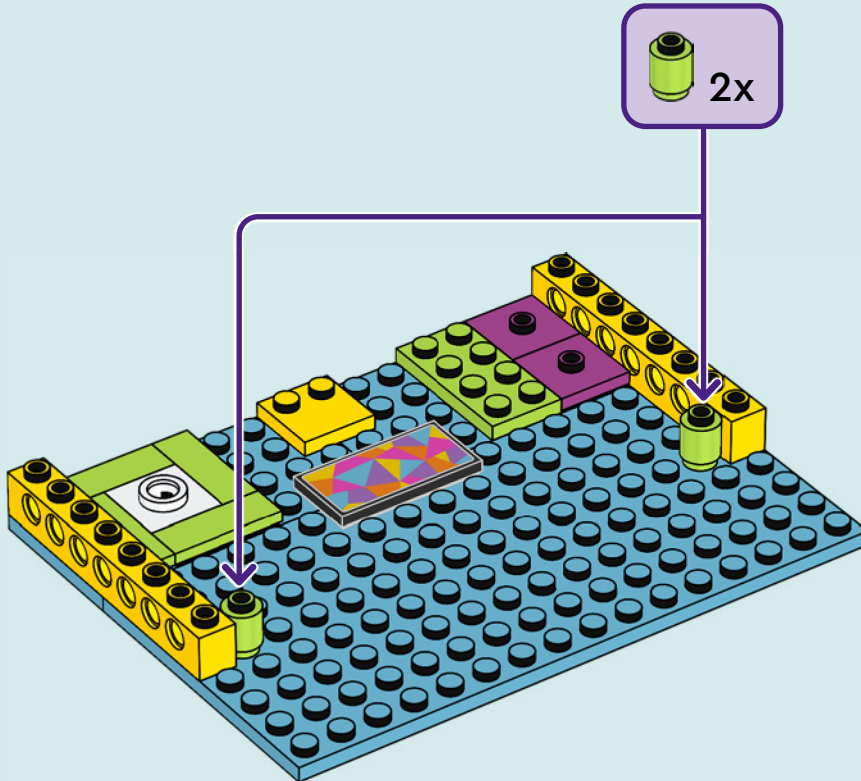

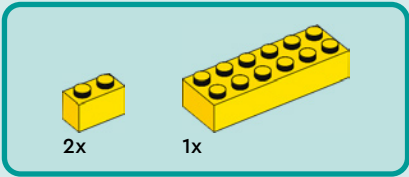

9

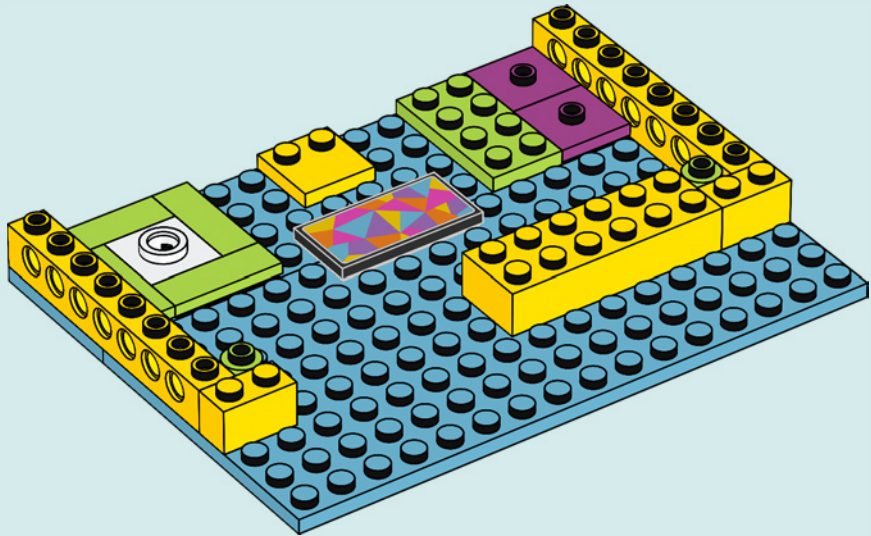



3x



3x

10

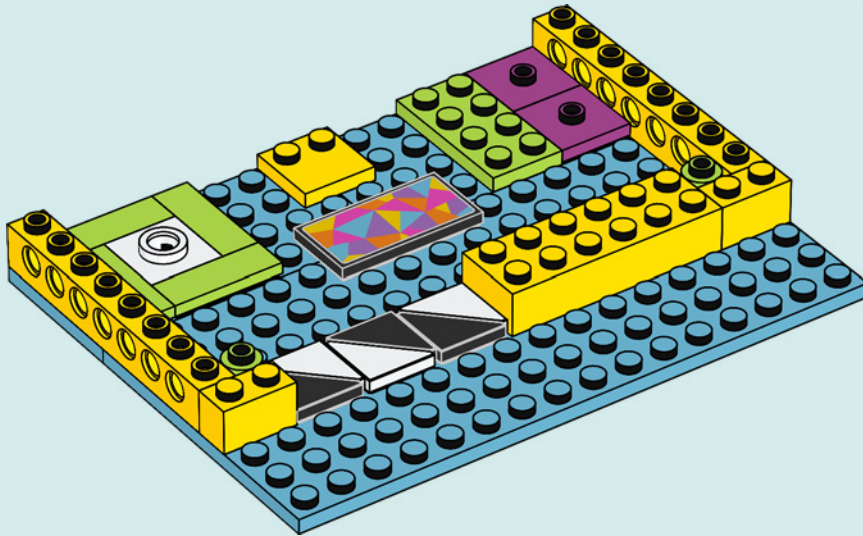



5x

11

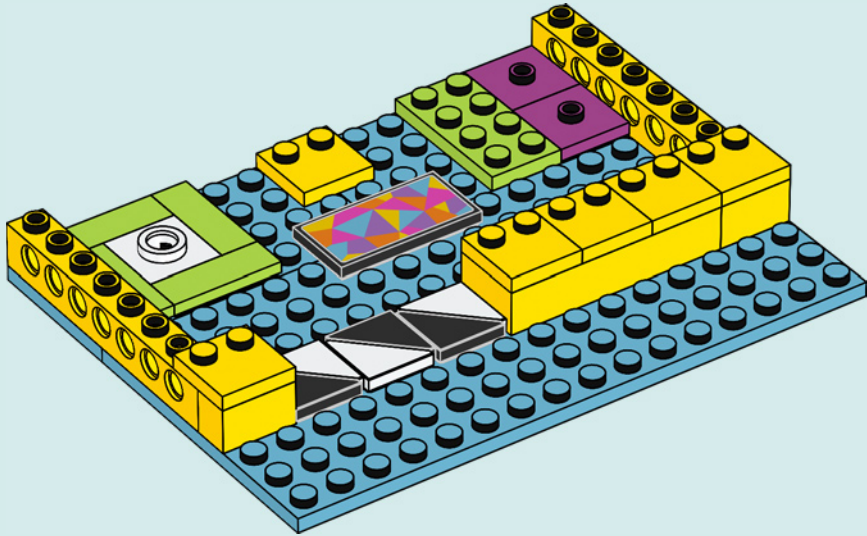

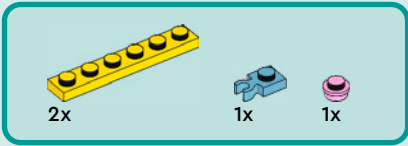

12

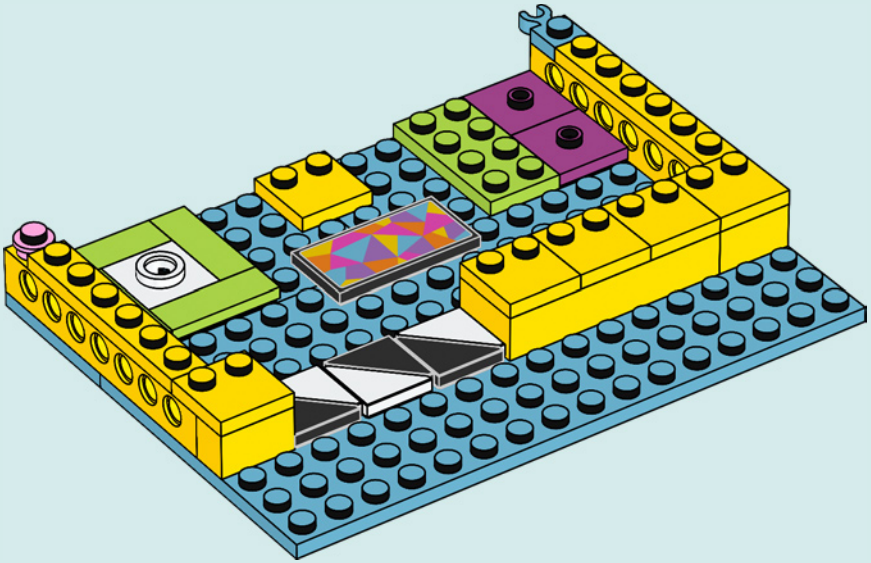

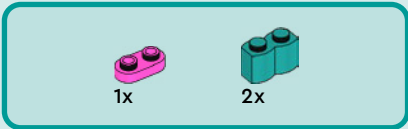

13

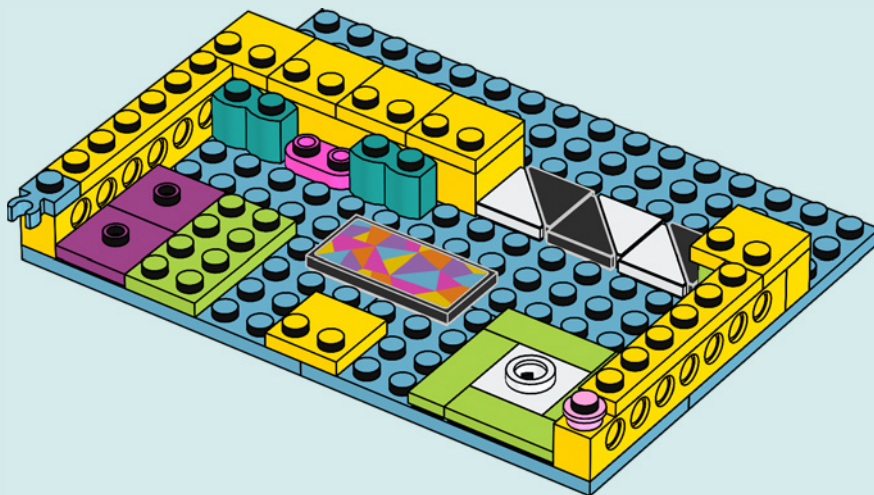



1x



2x

14

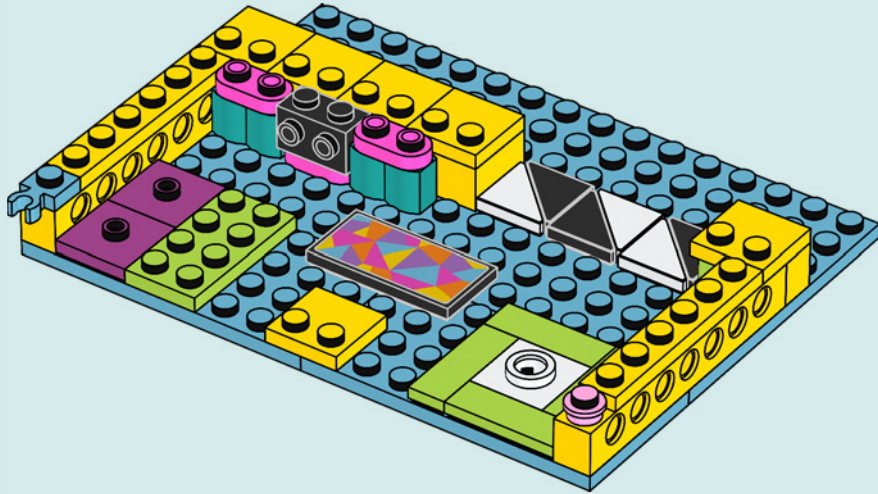



15

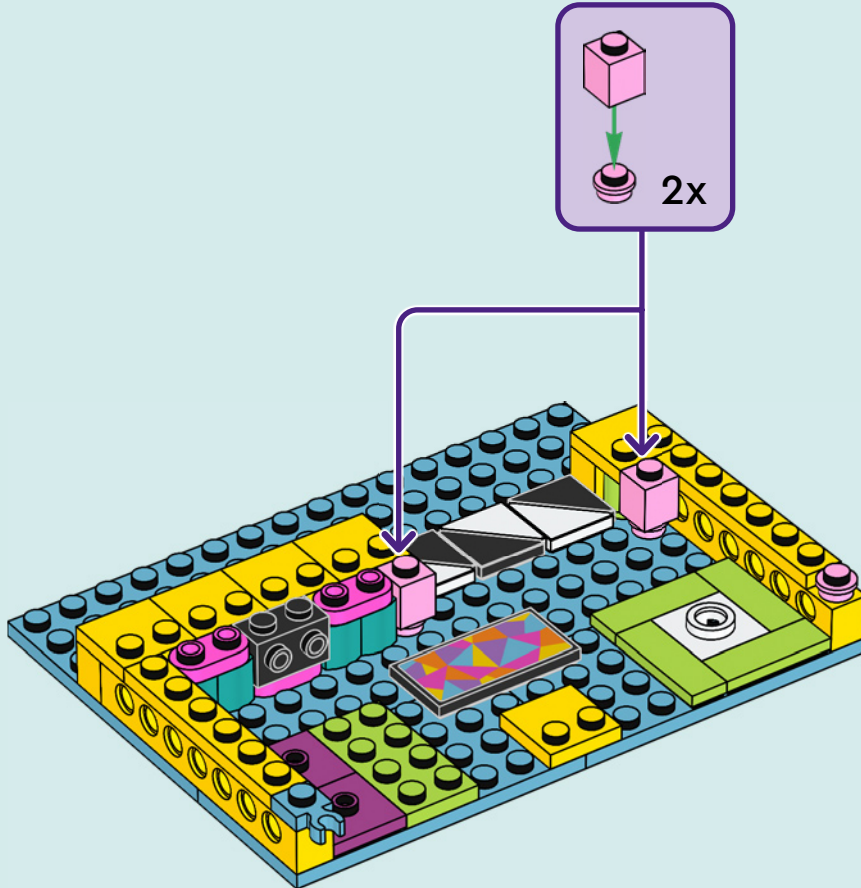



3x

16

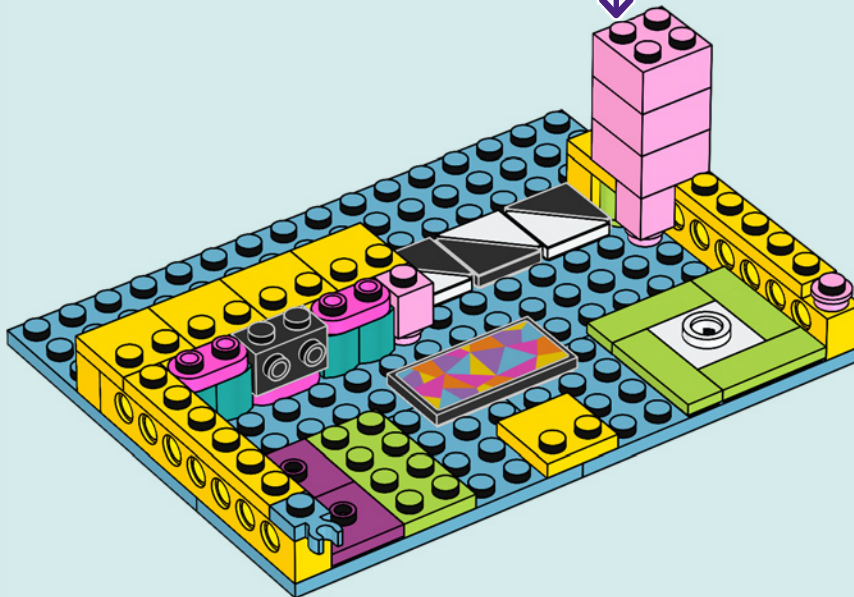
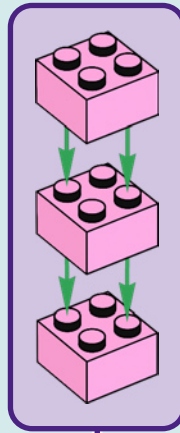

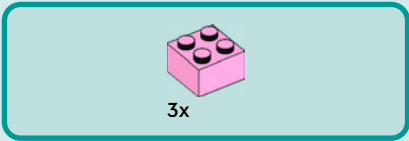

17

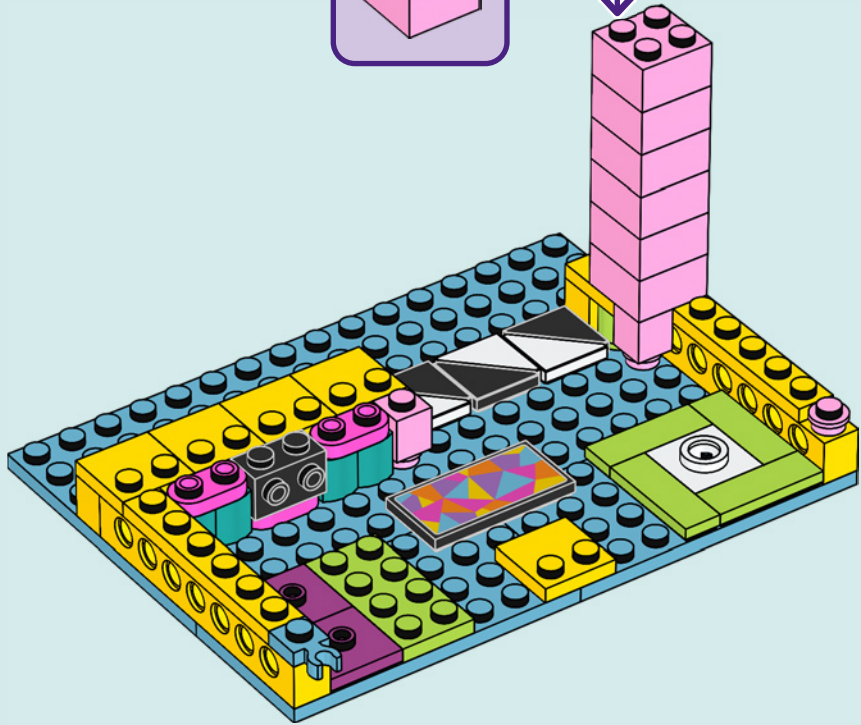
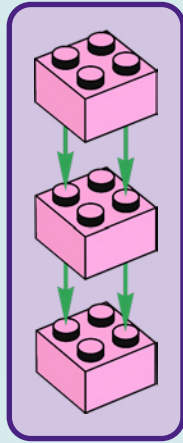

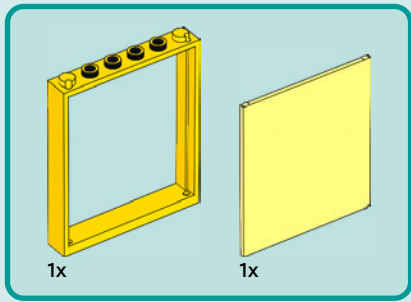

18

1

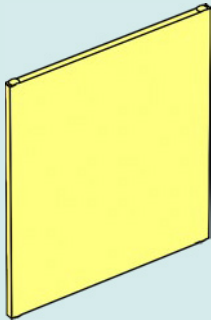

2



3

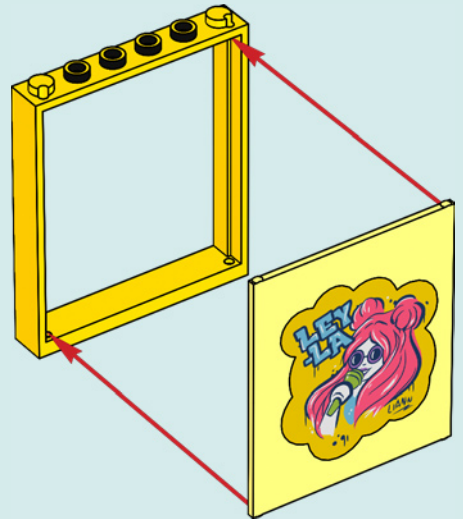

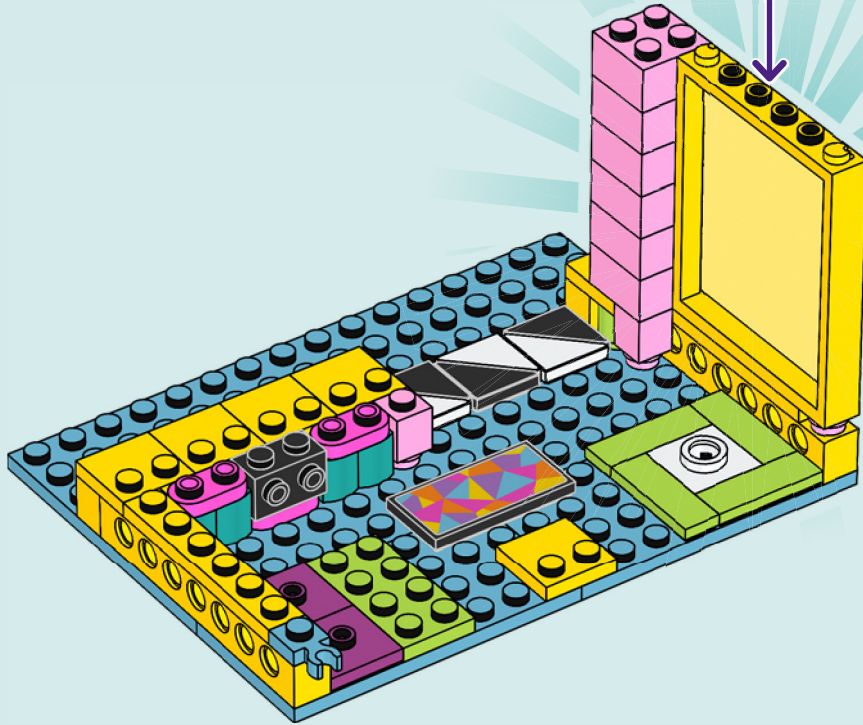

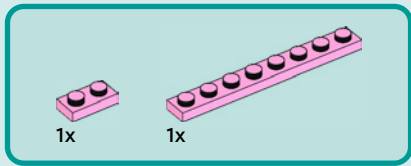

19

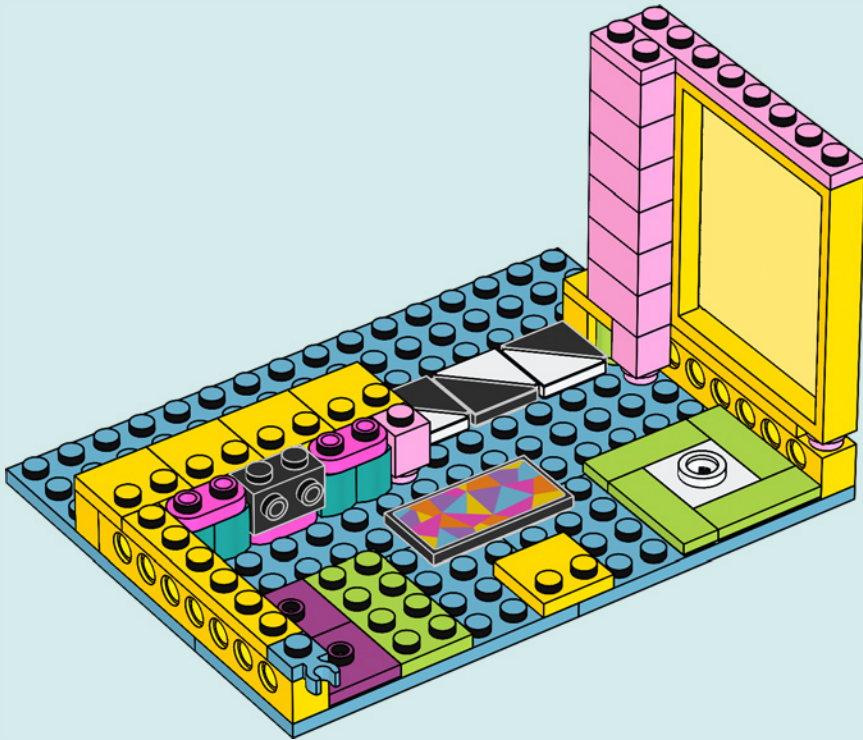

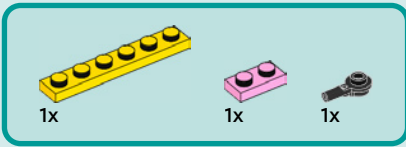

20

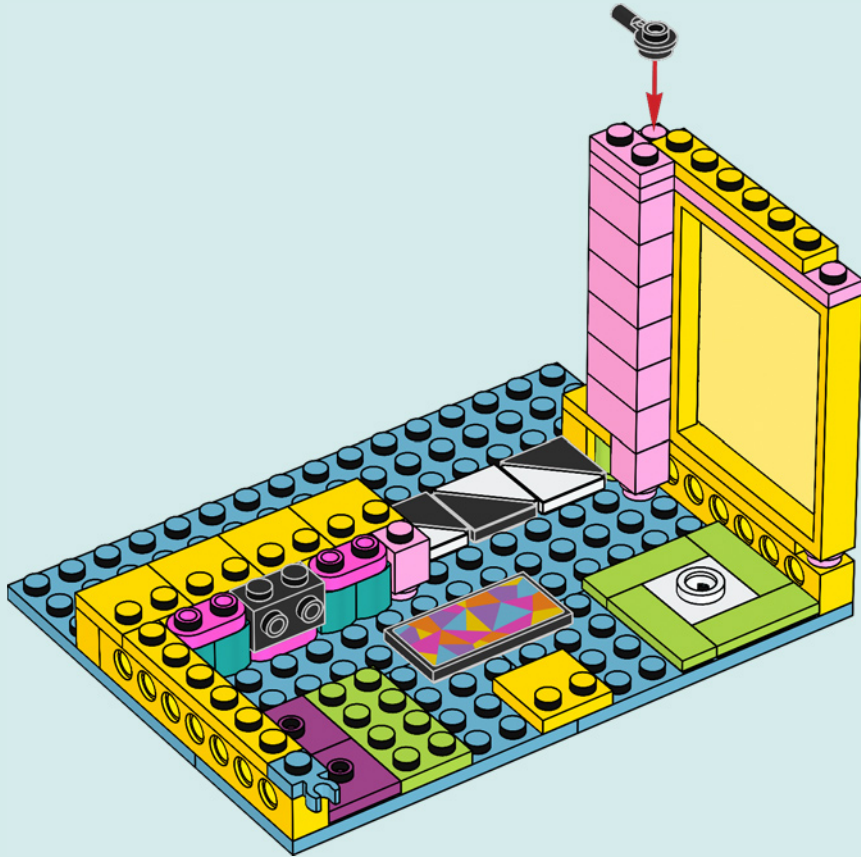



1x



1x

21

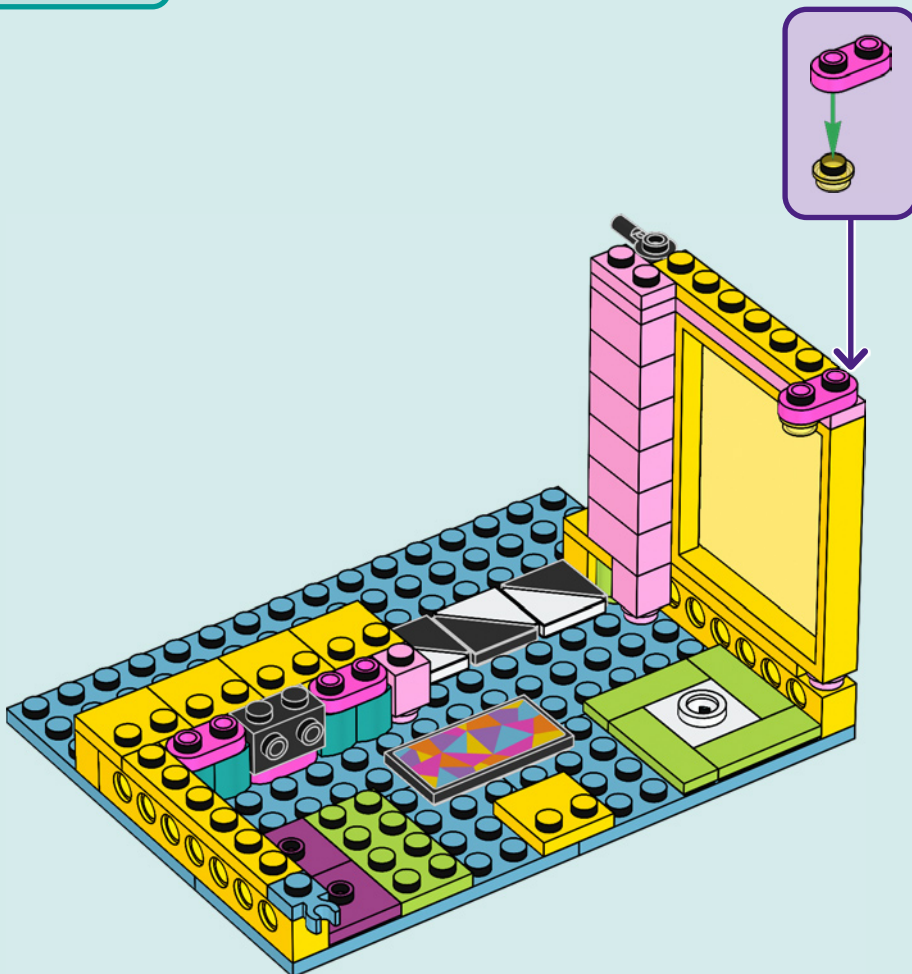

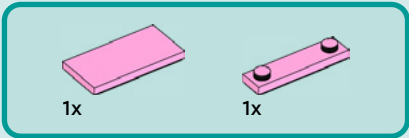

22

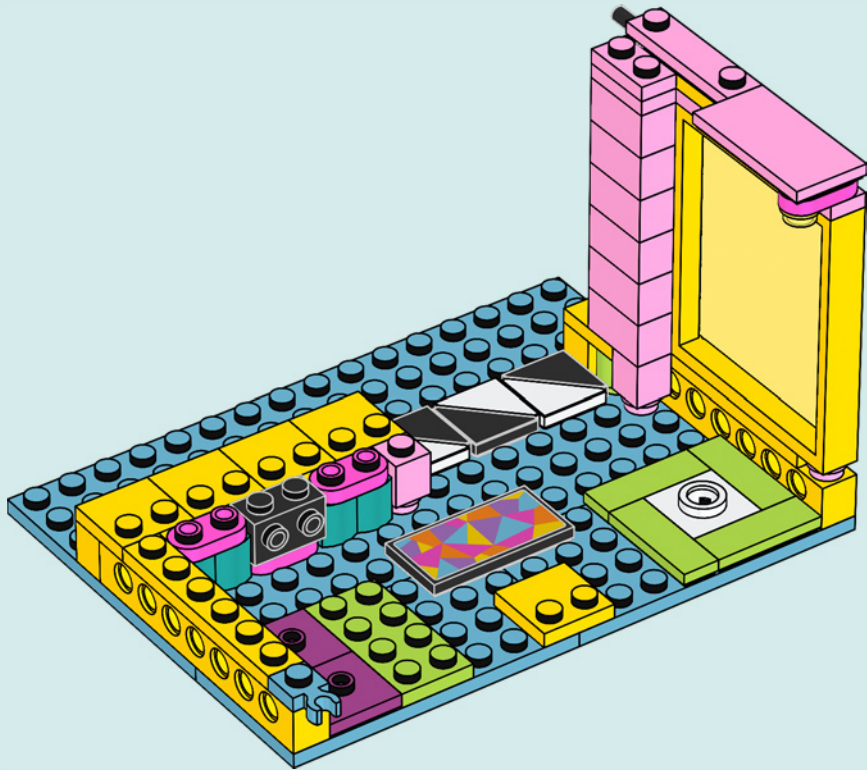

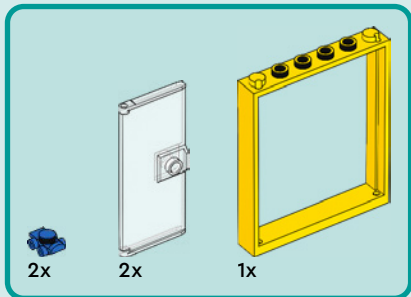
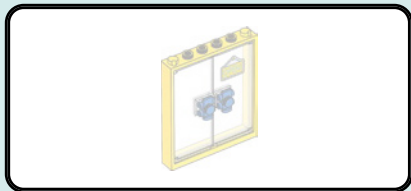

23

1

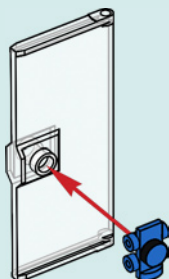

2

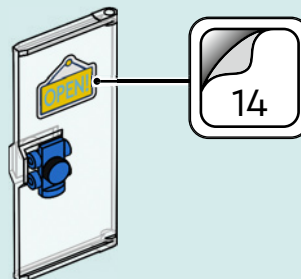

3

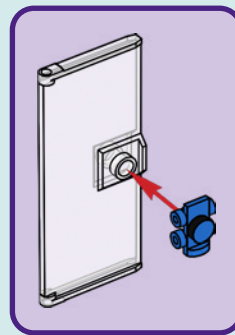
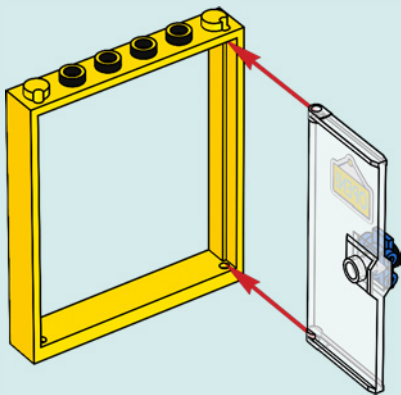

4

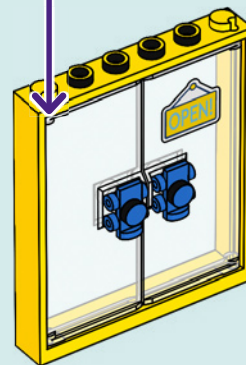

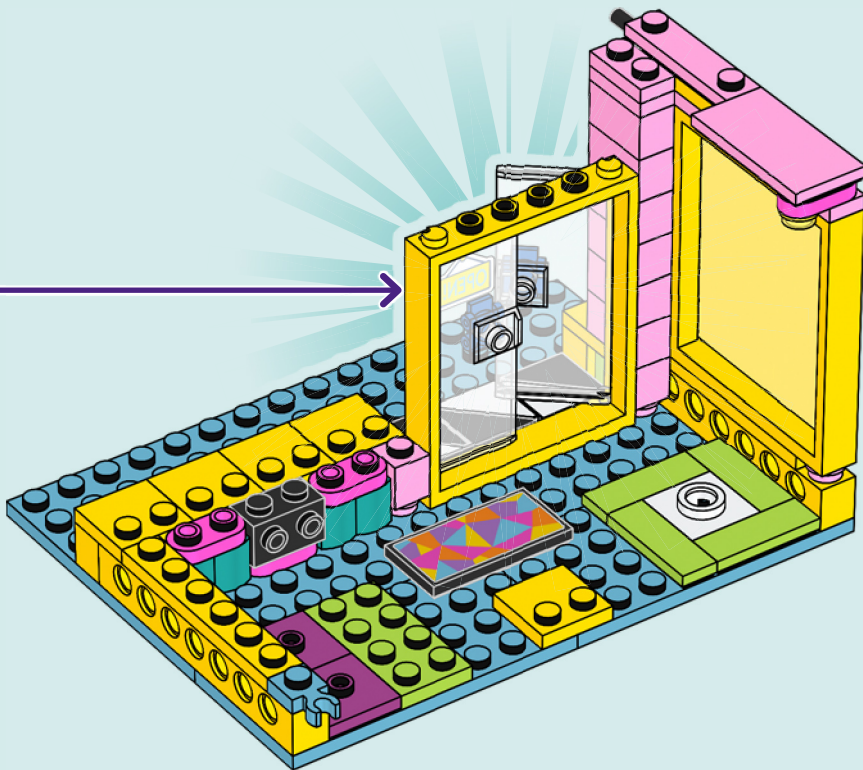

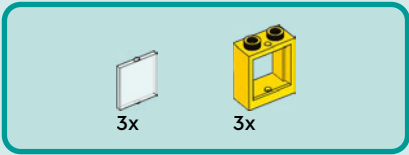

24

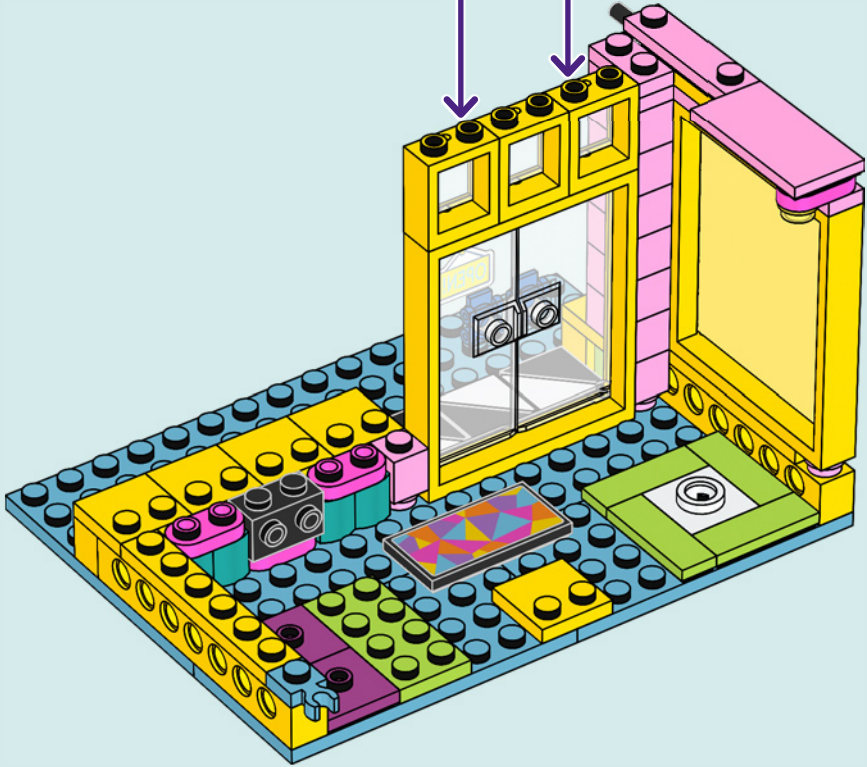
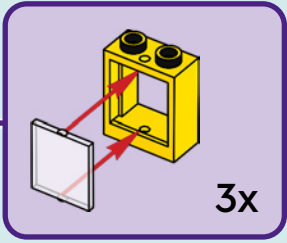



1x

25

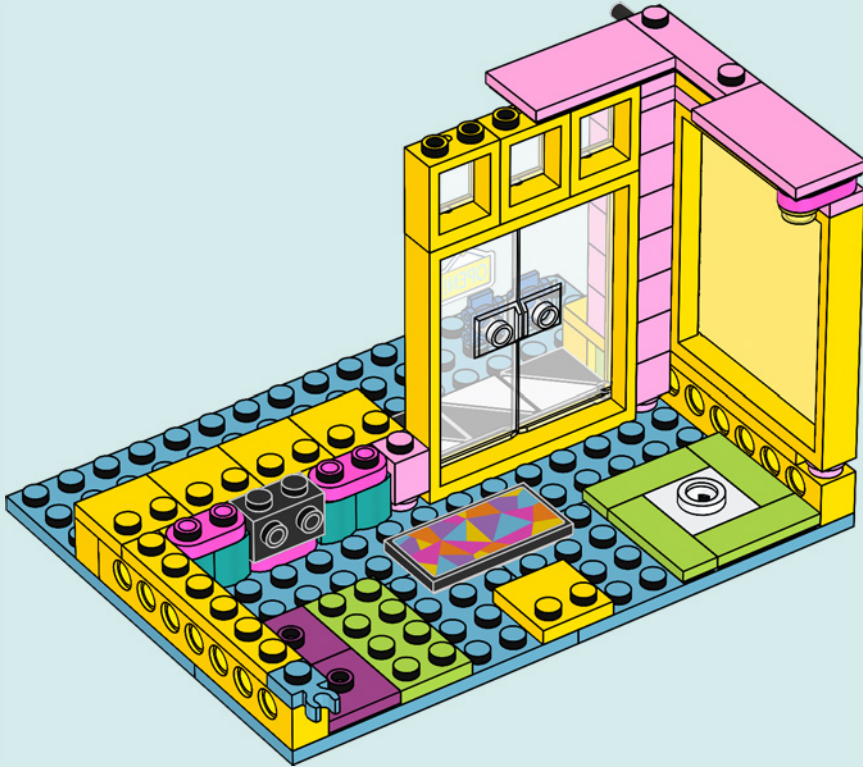

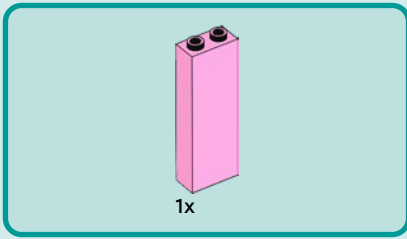

26

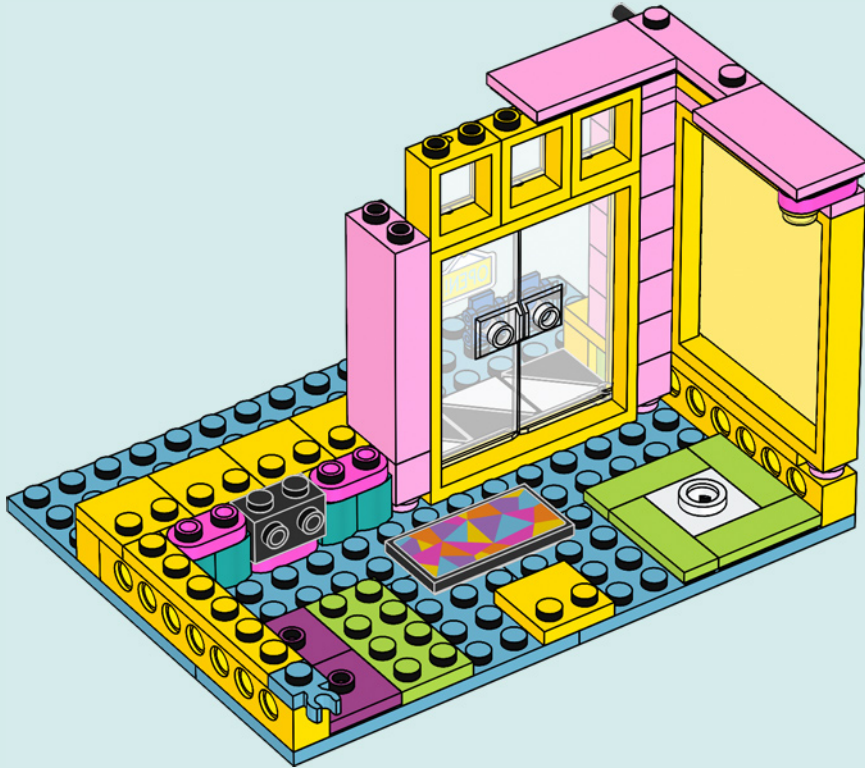



1x



1x

27

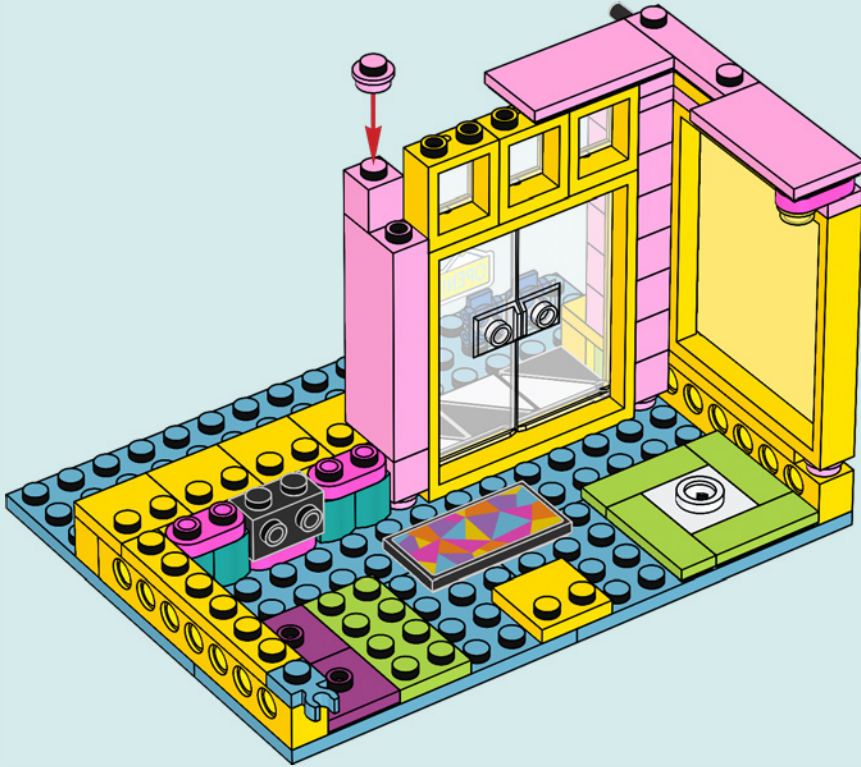

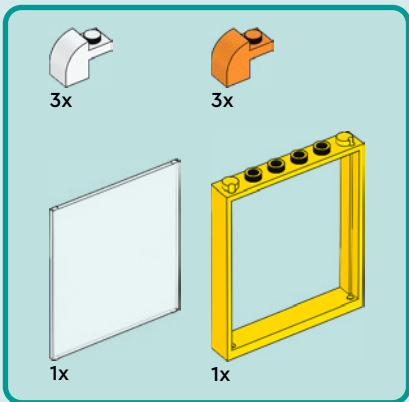
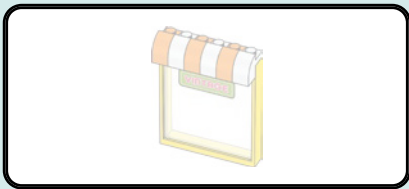

28

1

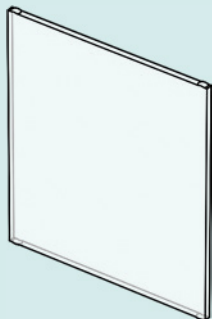

2



3

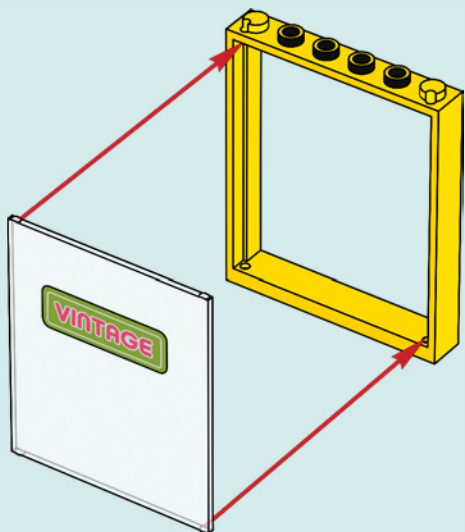

4

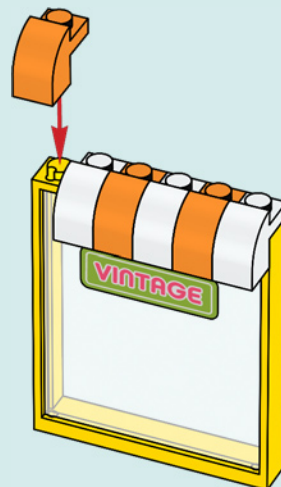

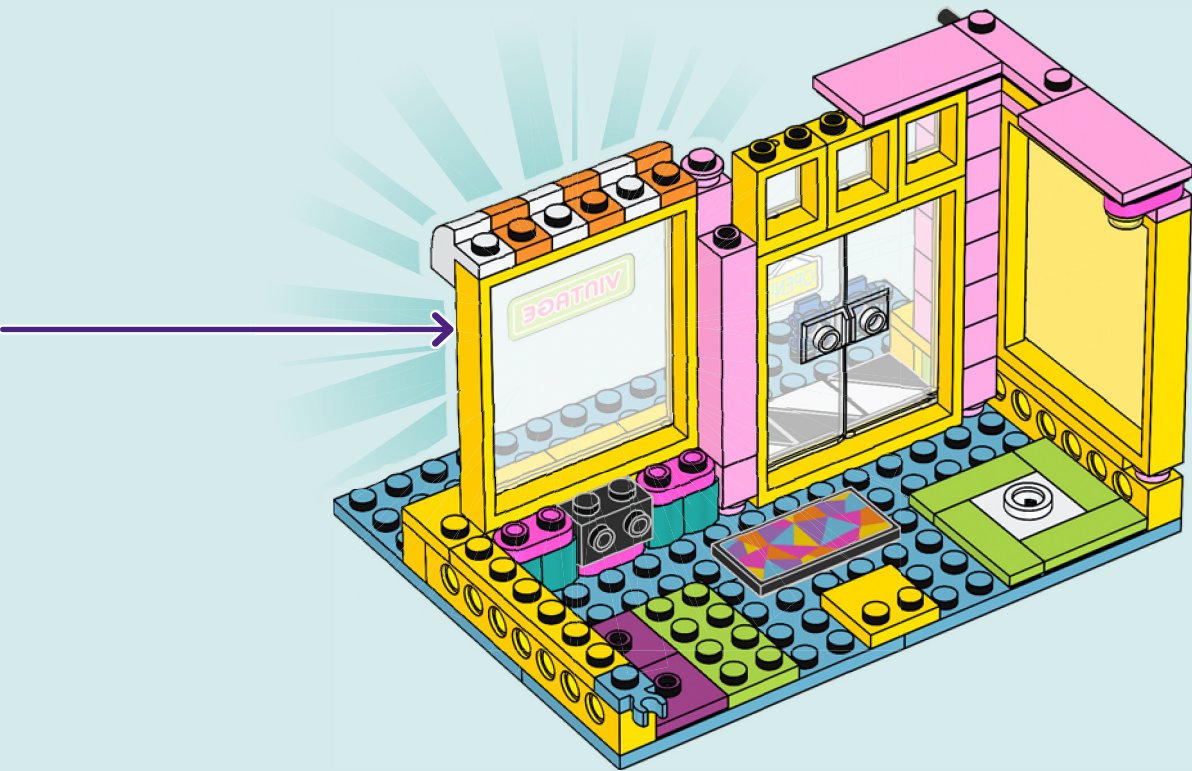

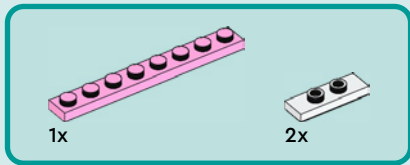

29

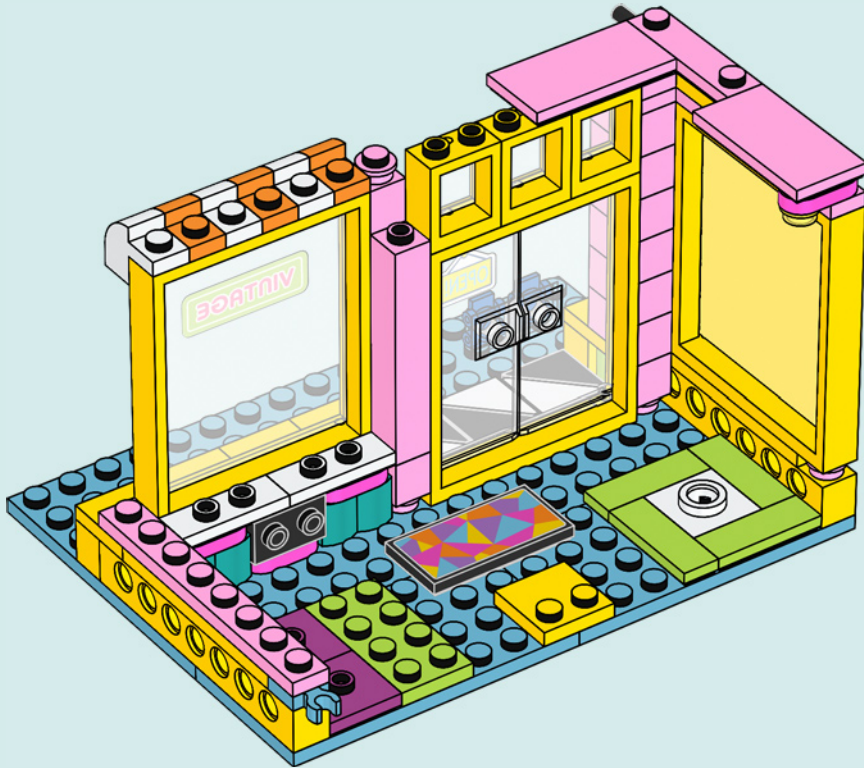

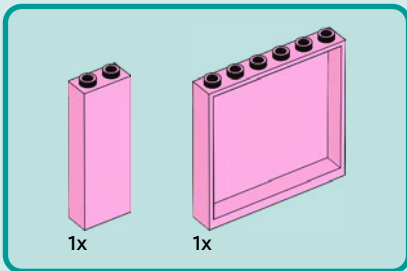

30

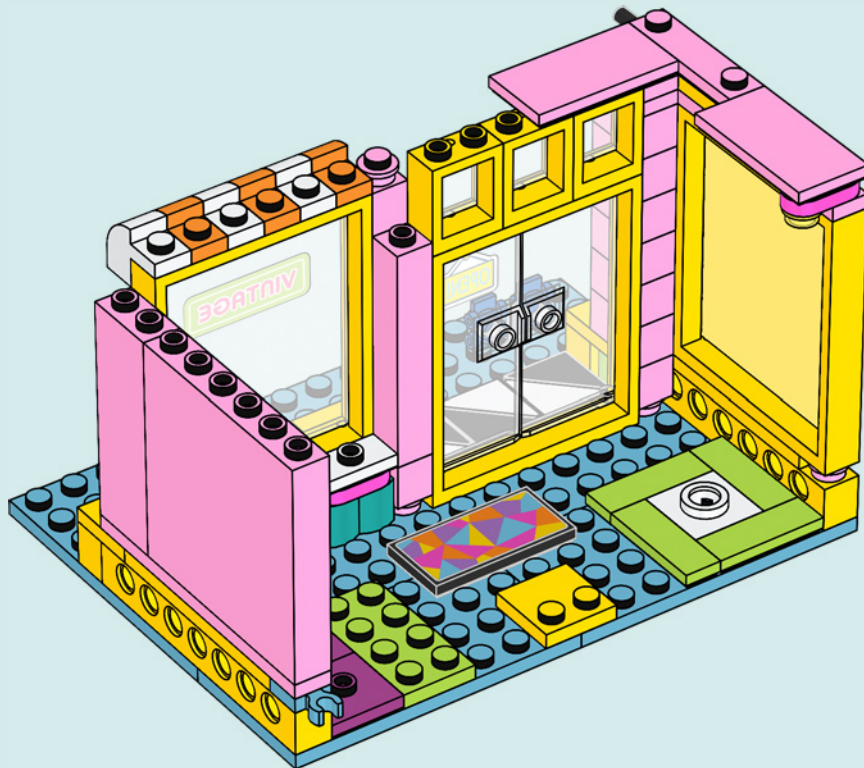

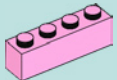

2x

31

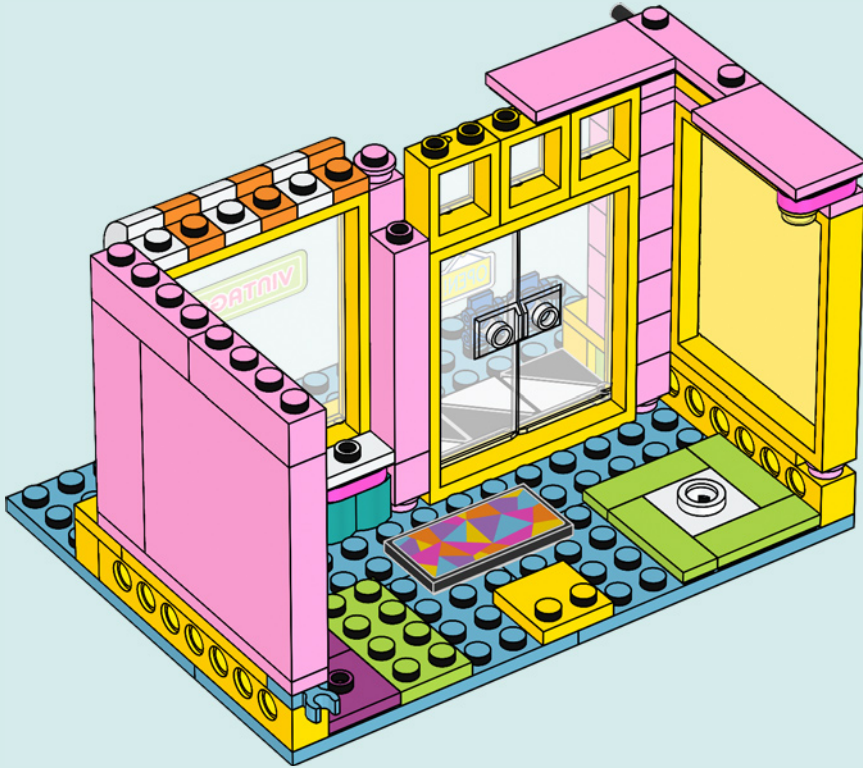

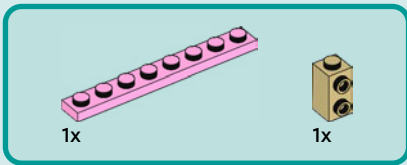

32

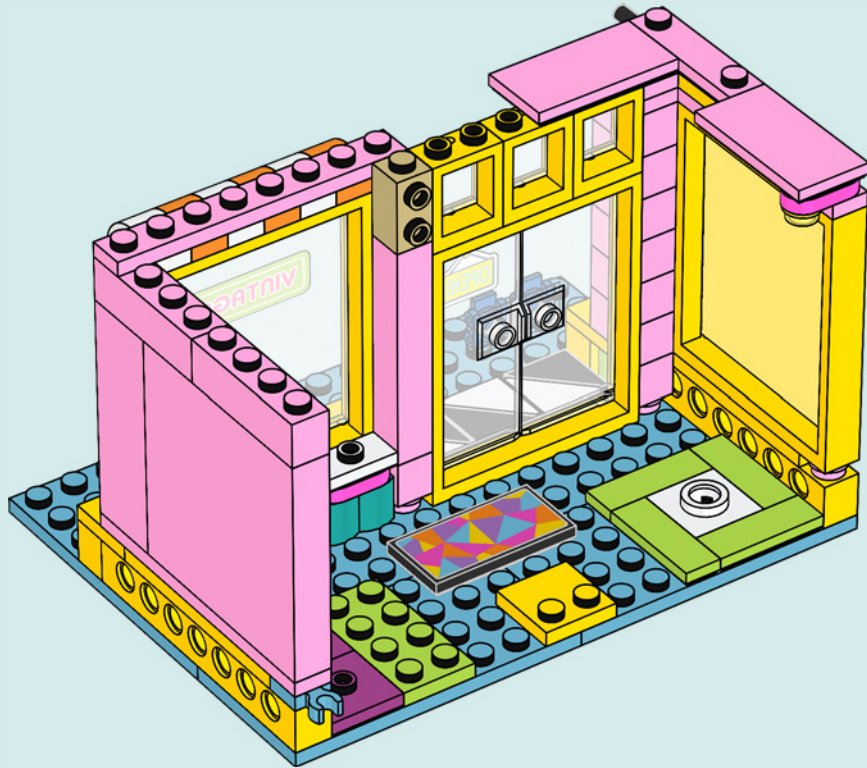

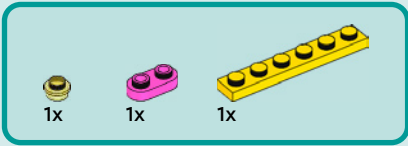

33

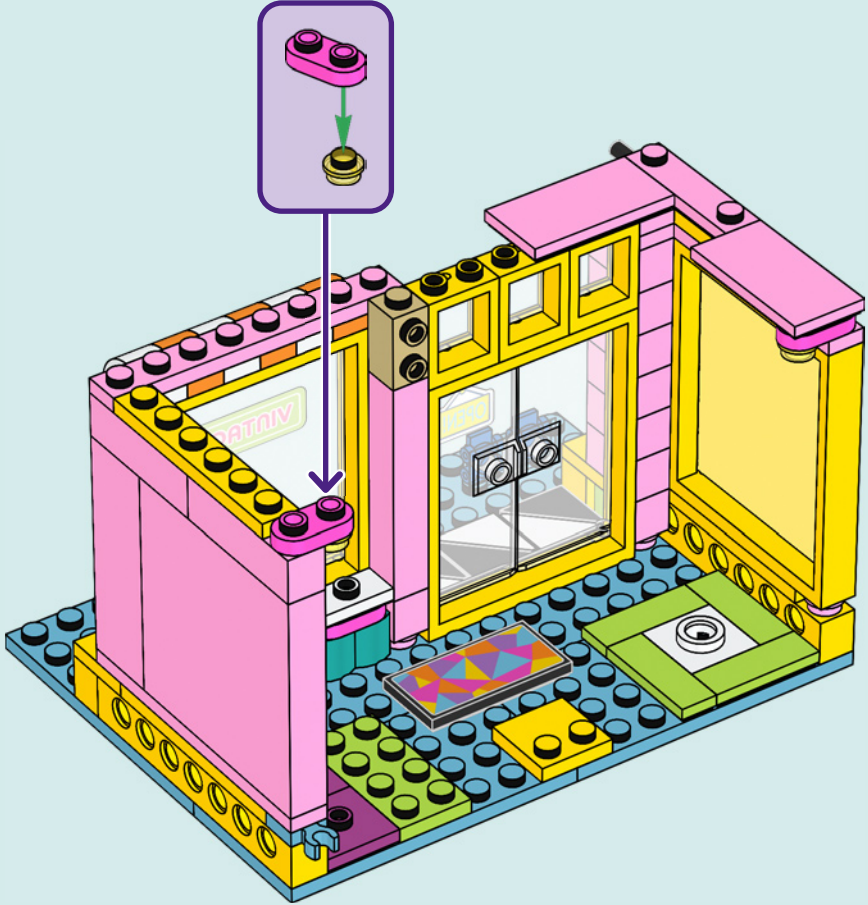

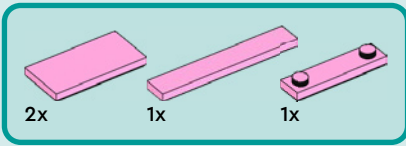

34

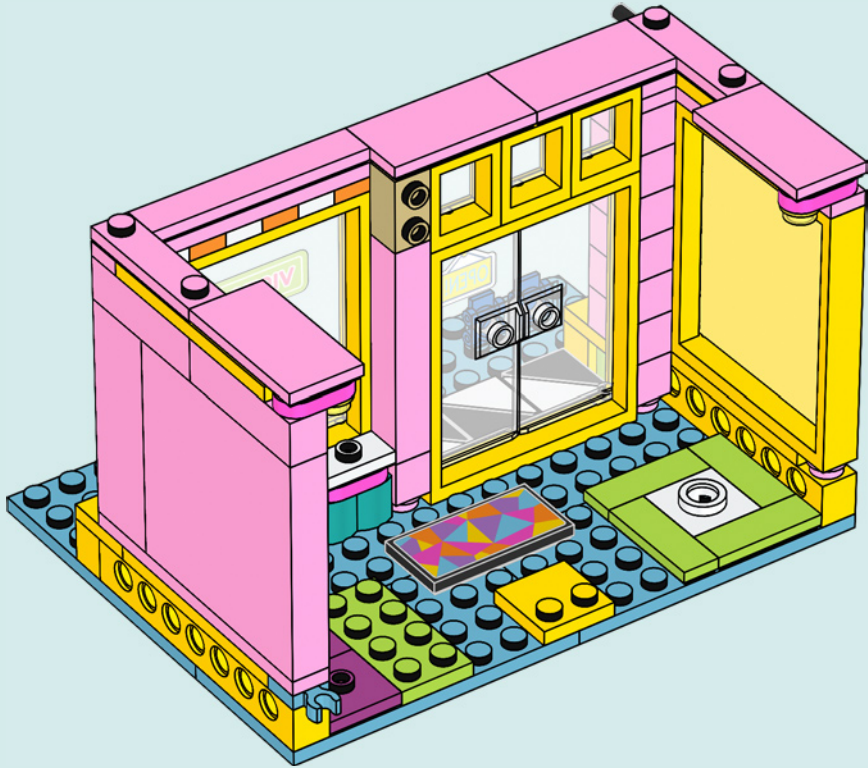





1x



1x

35





1x

36

1



2

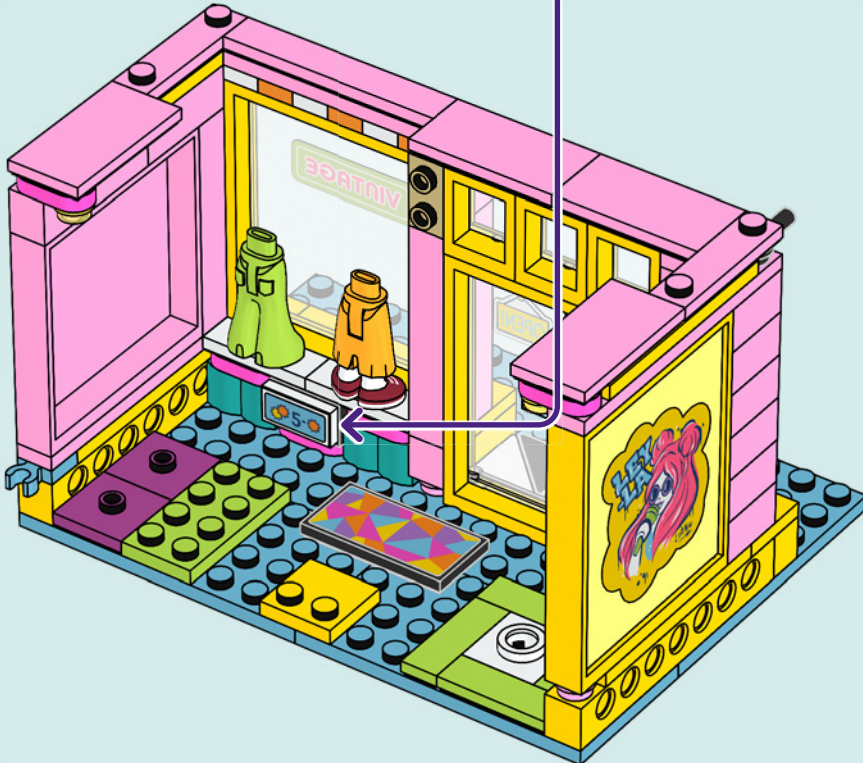

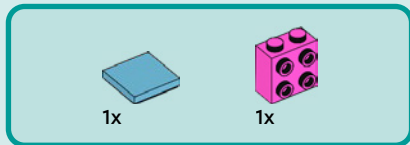

37

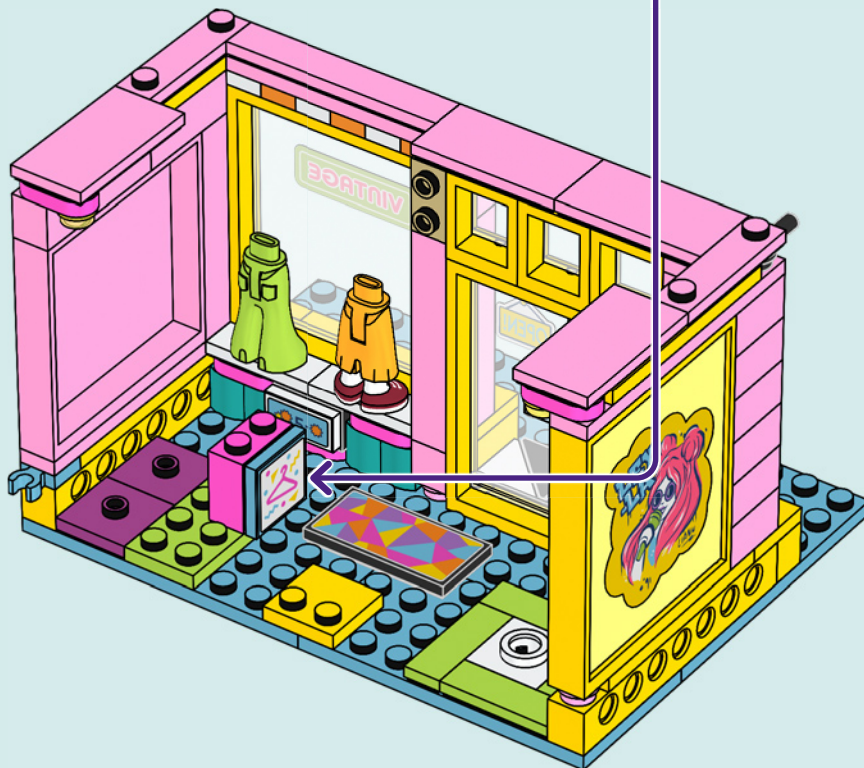
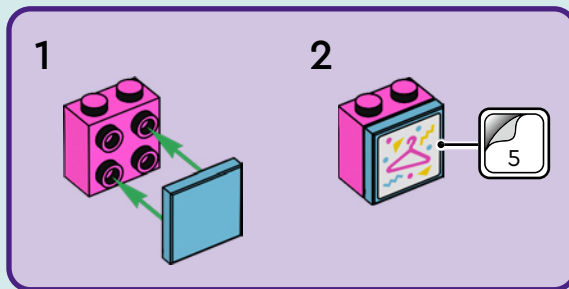



2x

38



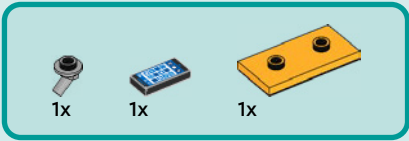

39

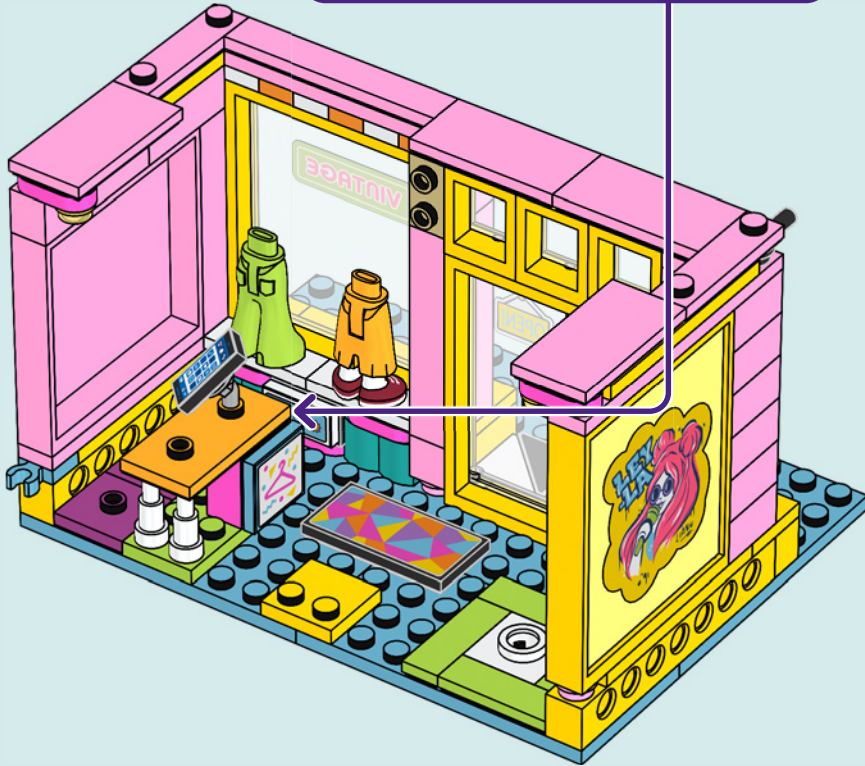
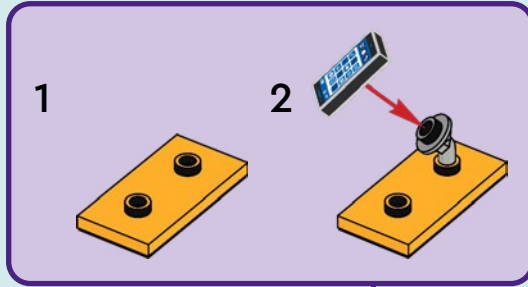

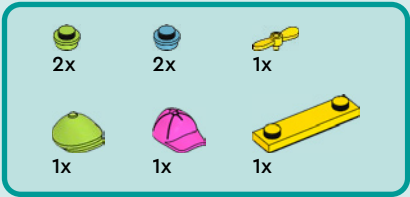

40

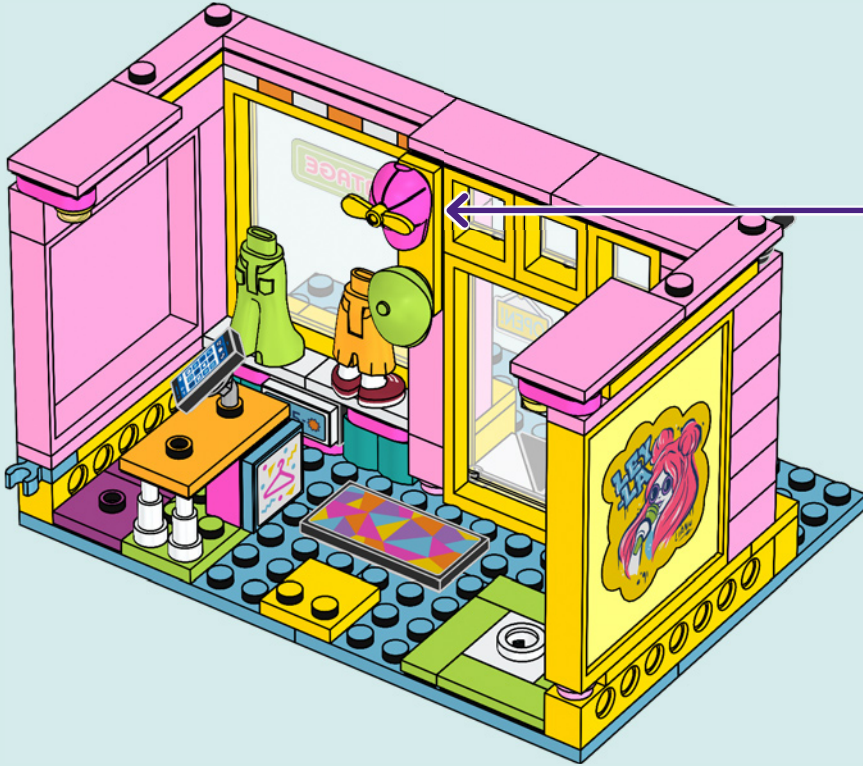
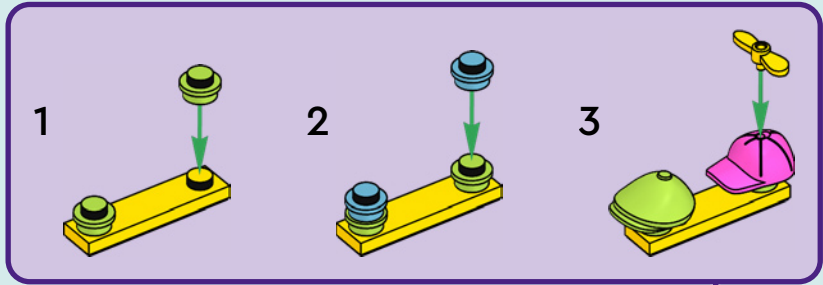

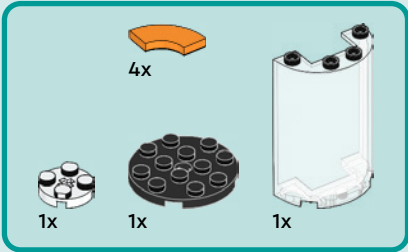
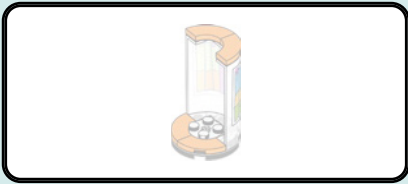

41

1



2



3



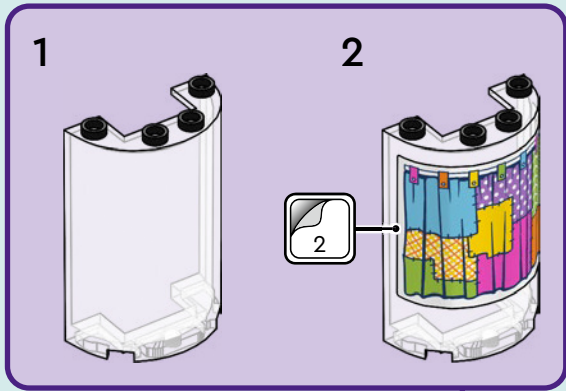

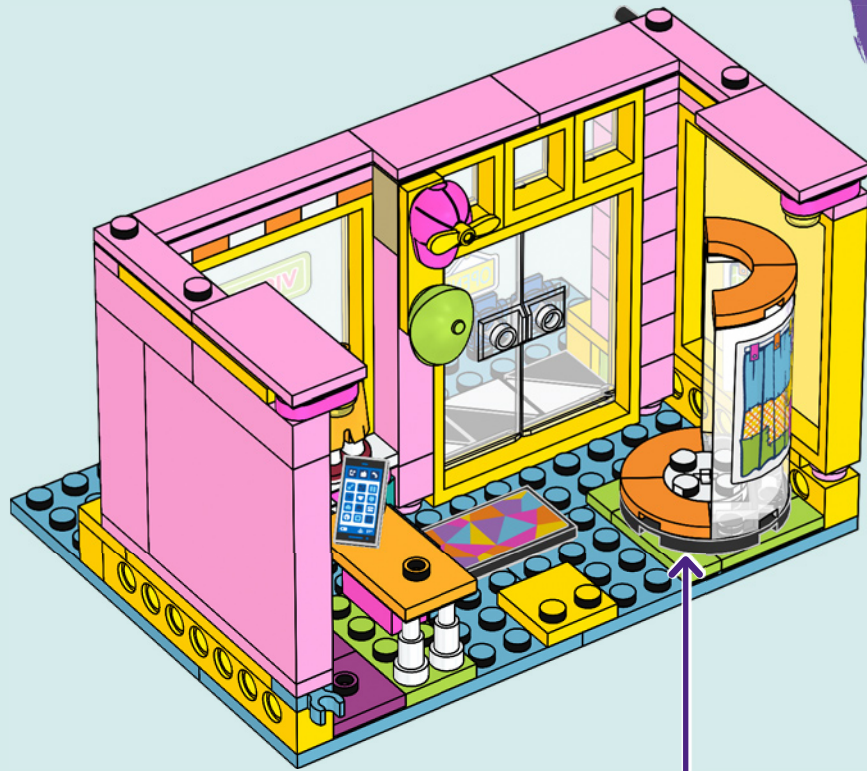

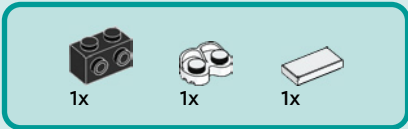

42

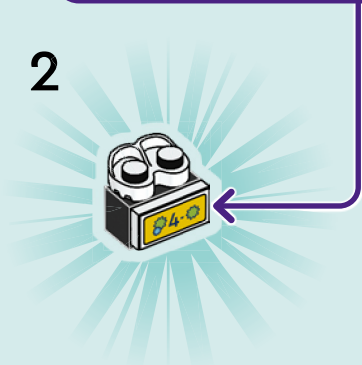
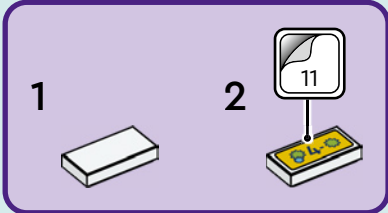
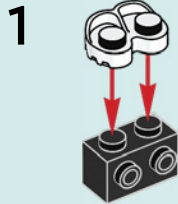





1x

43





8x



8x

44

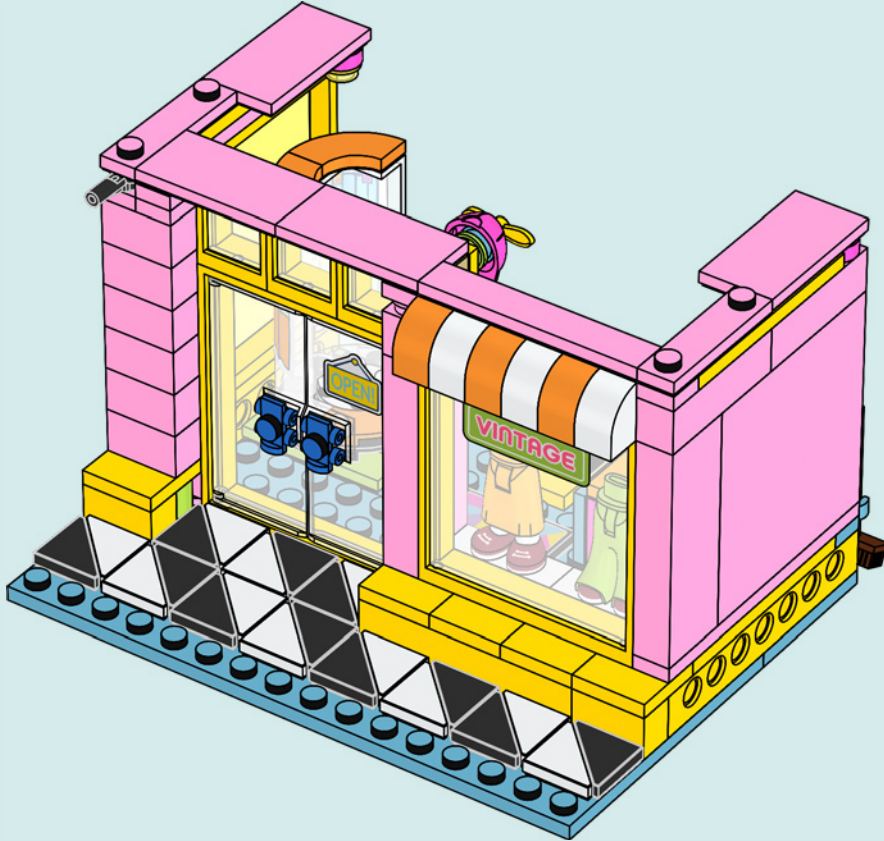

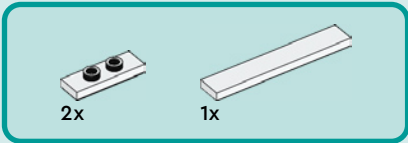

45

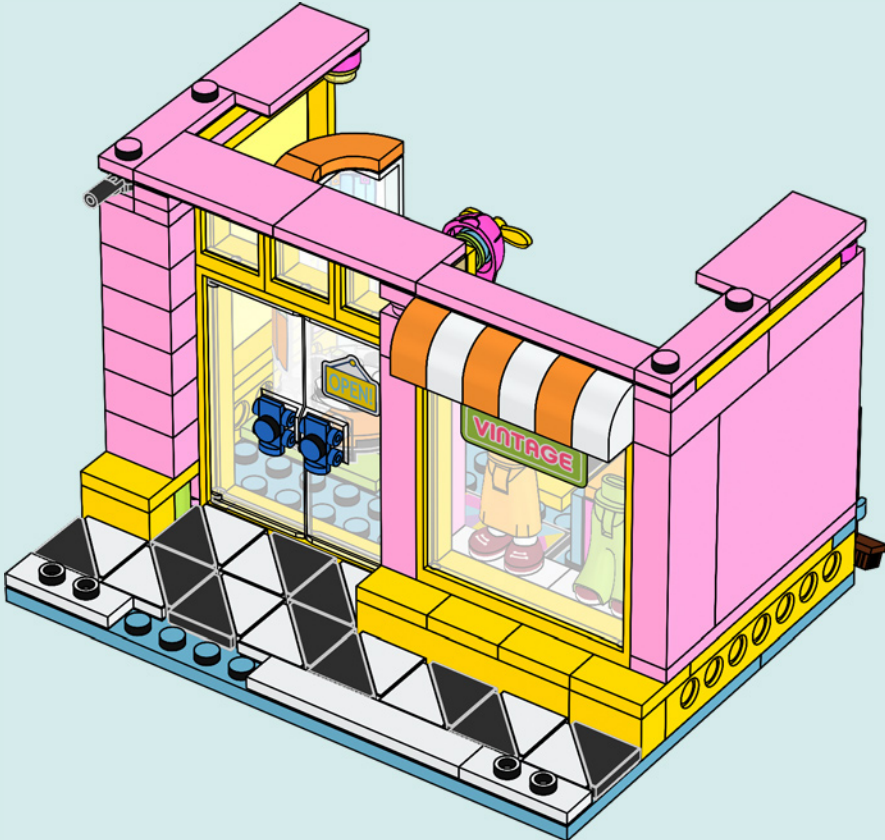



2x



1x

46

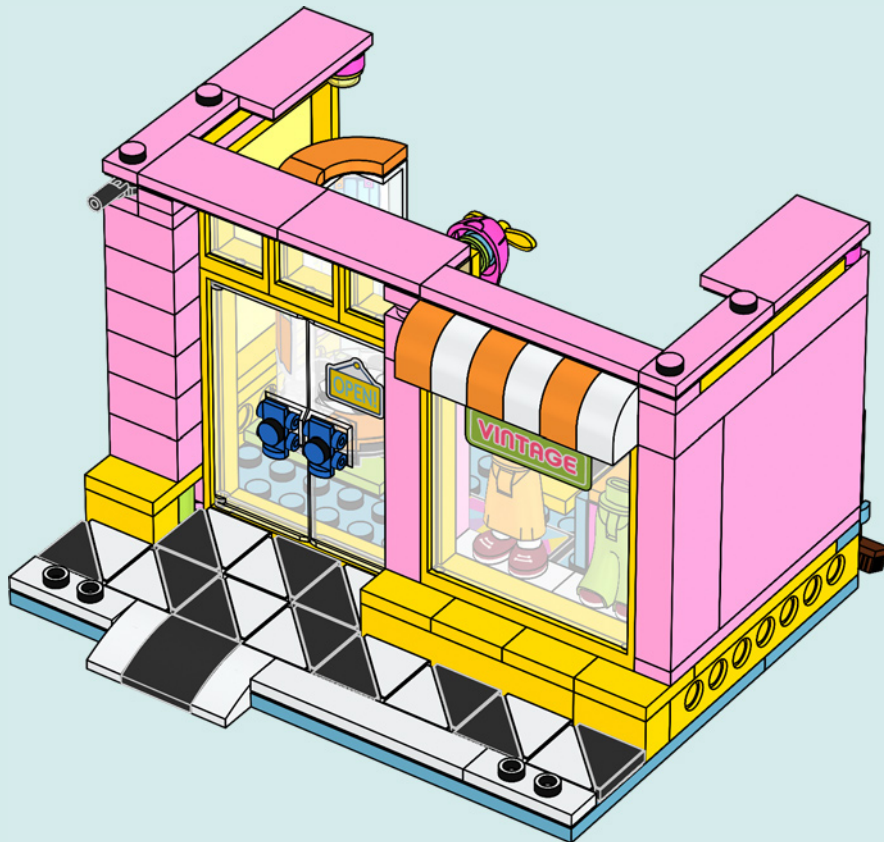

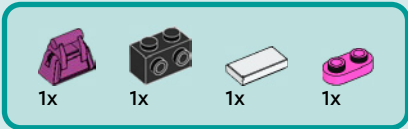

47

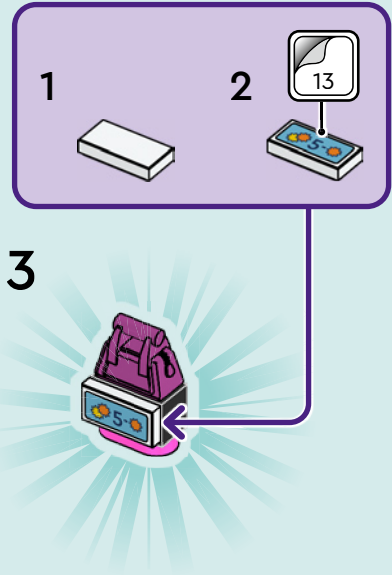
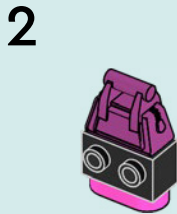
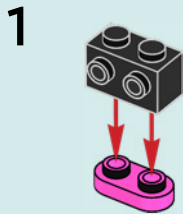

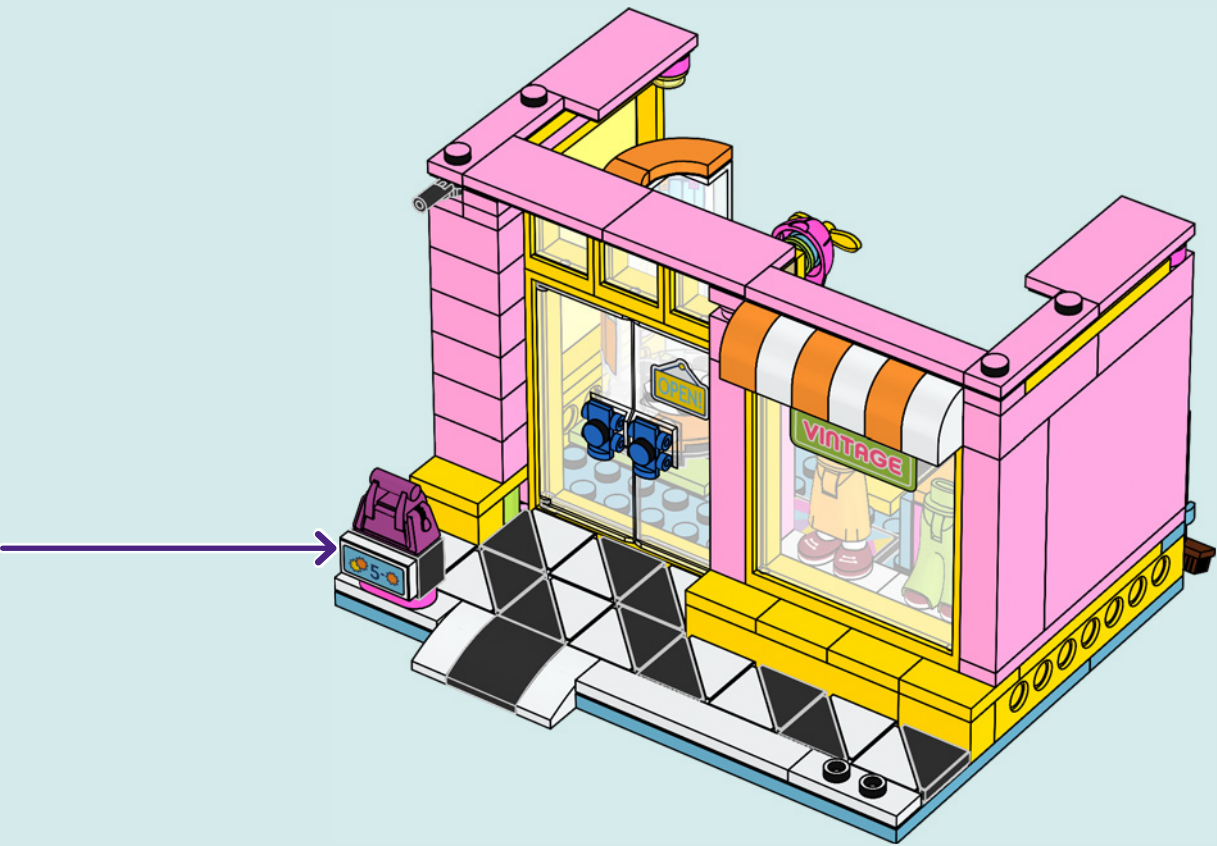

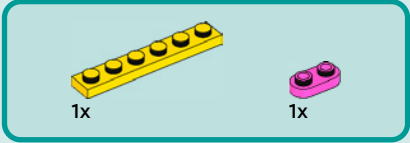

48

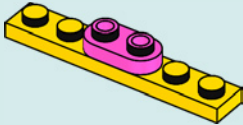

49

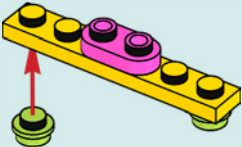



3x

50

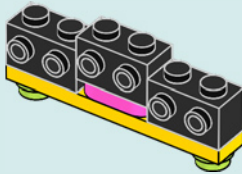

2x

51

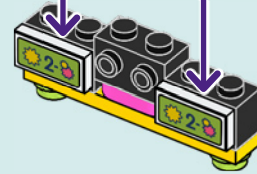
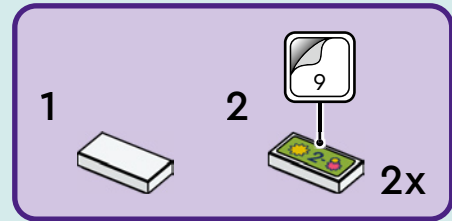



1x

52

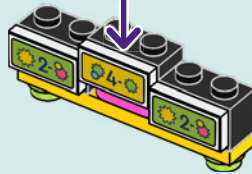
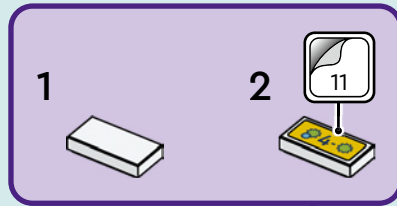



2x



1x

53

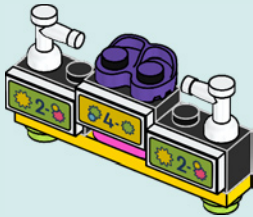

1x



1x

54

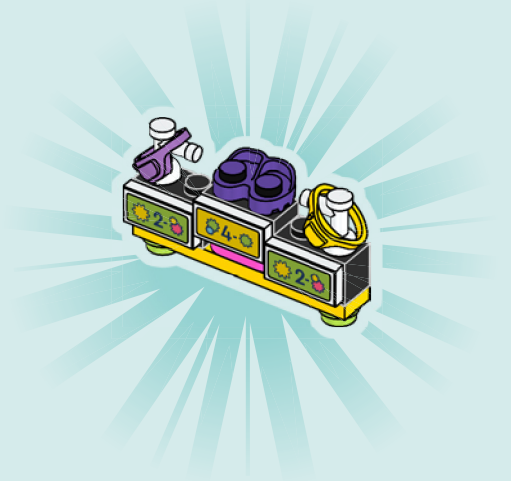

55

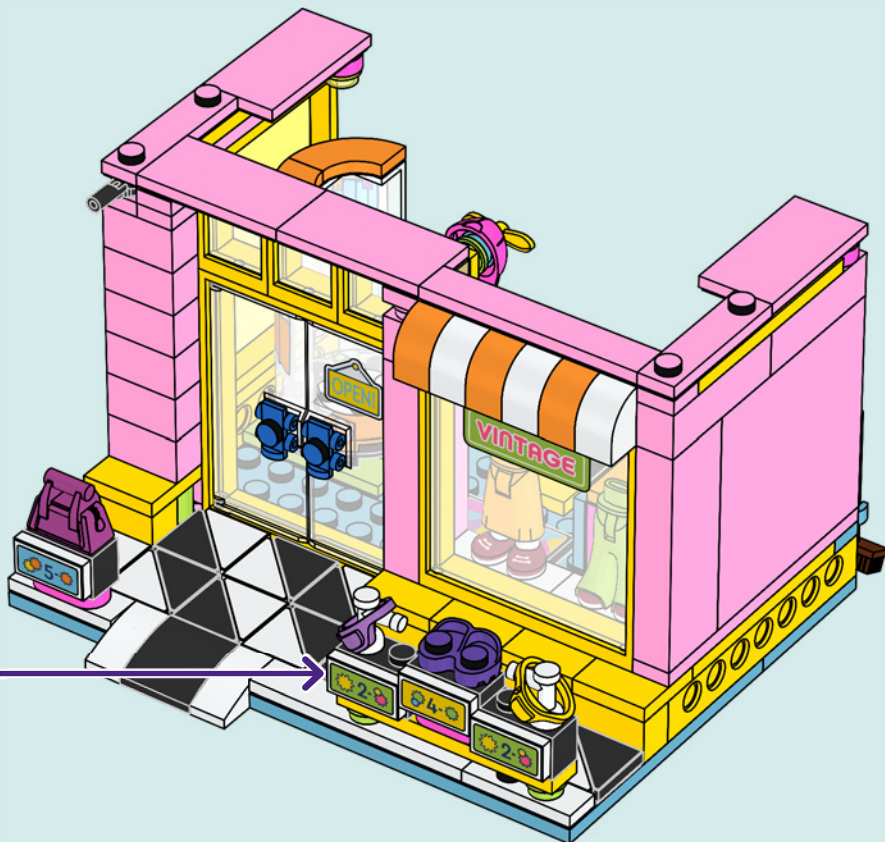

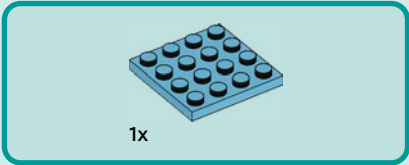
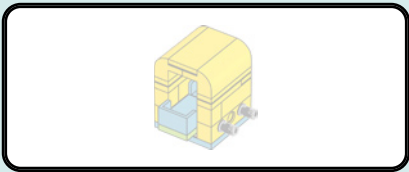

56

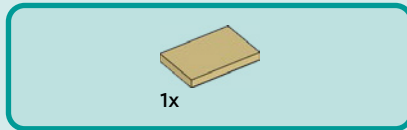
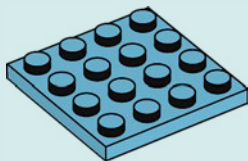

57

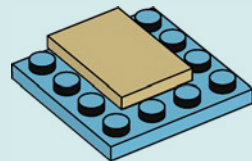

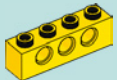

2x

58

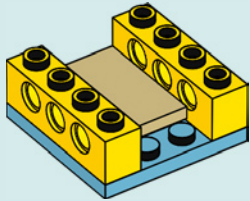

1x

59

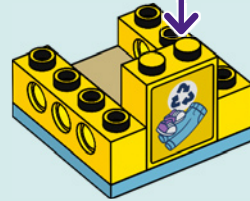
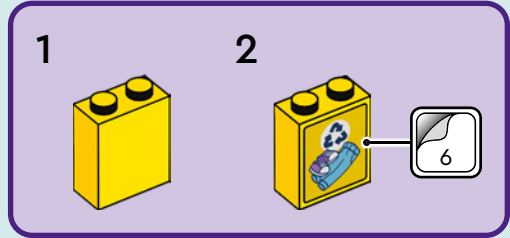

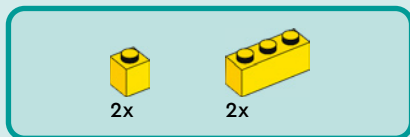

60

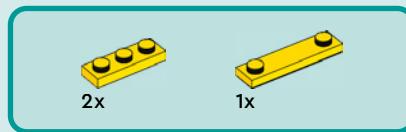
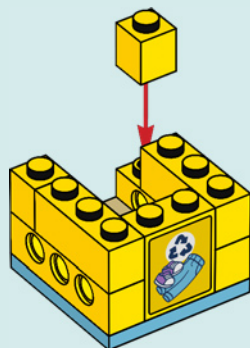

61

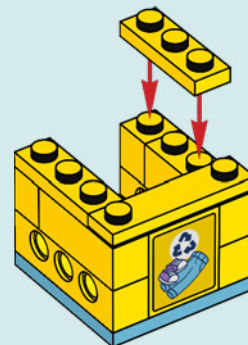



2x

62

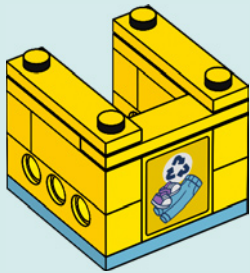

2x

63

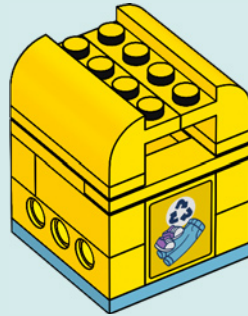

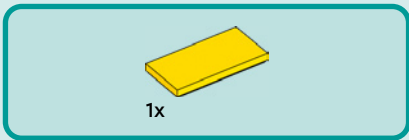

64

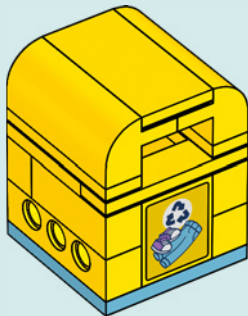

65

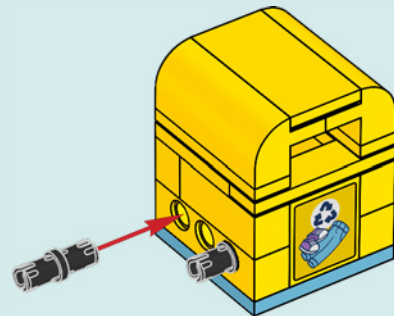

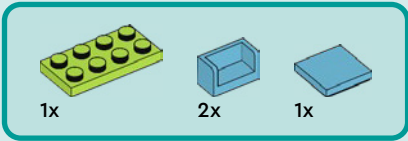

66

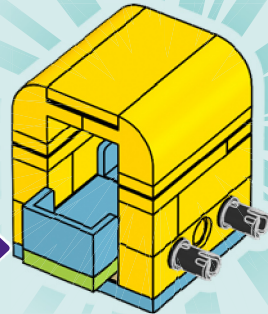
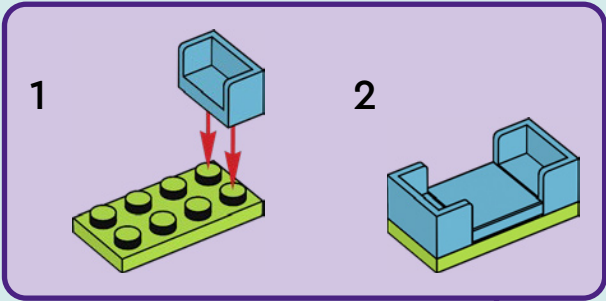

67

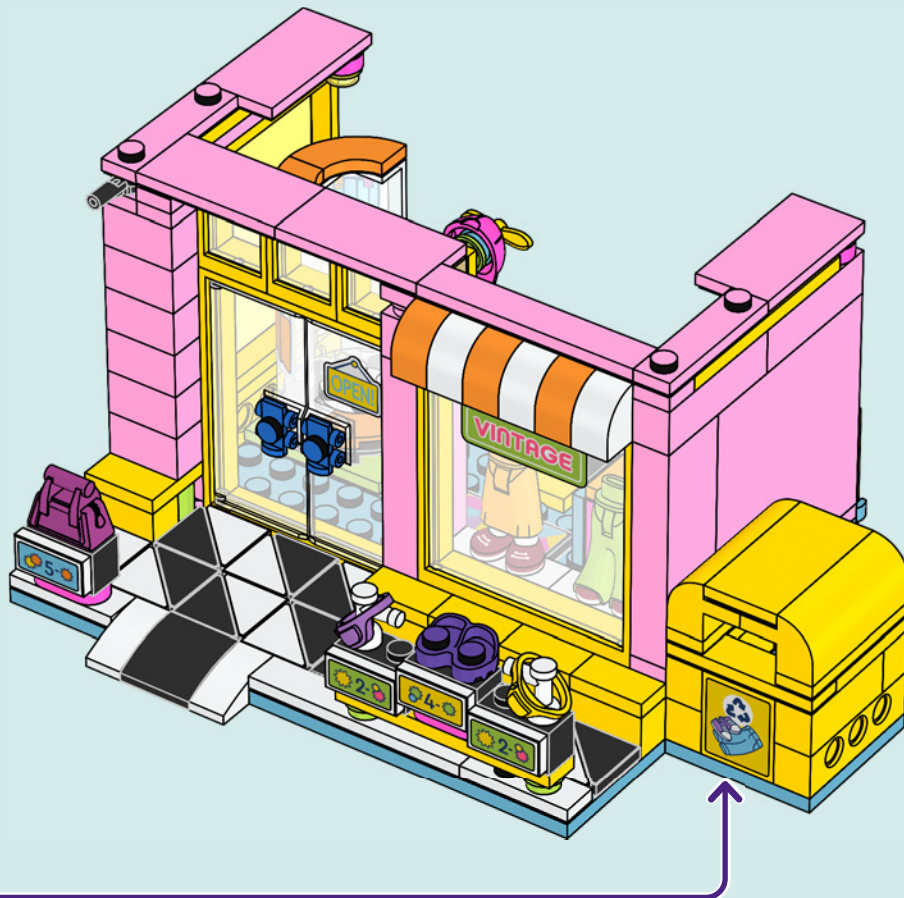

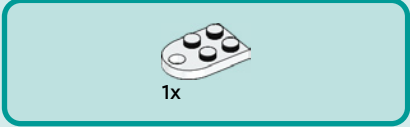
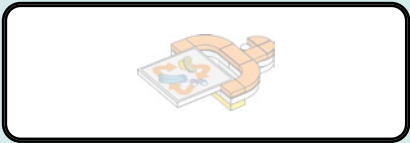

1x

68

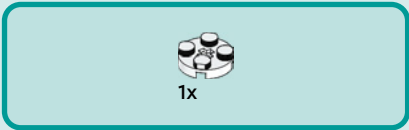

1x

69

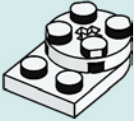

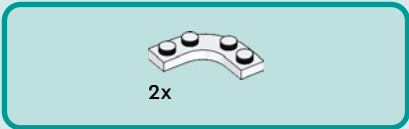

70

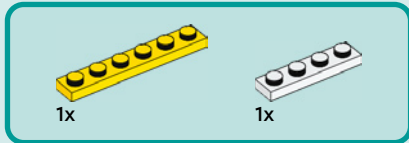
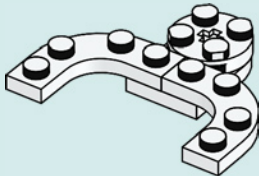

71

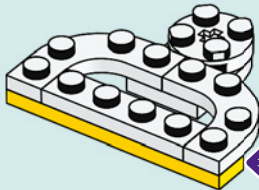
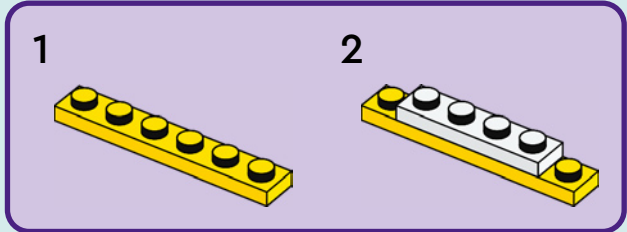

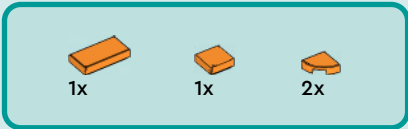

72

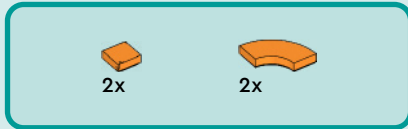
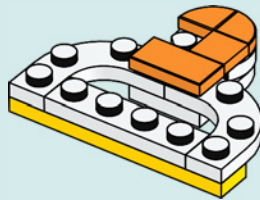

73

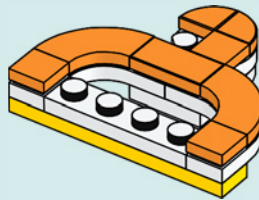

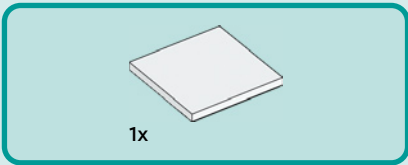

74

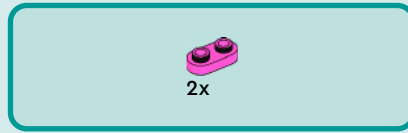
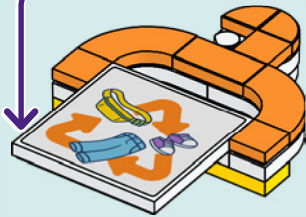
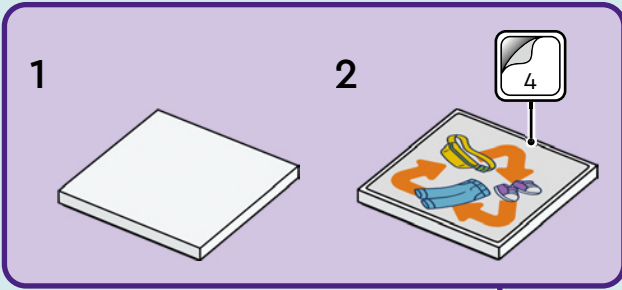

75

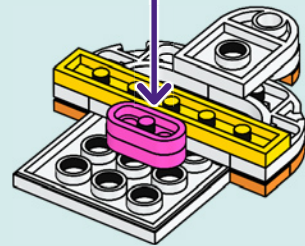
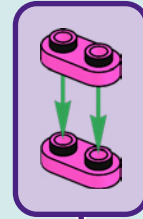
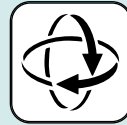

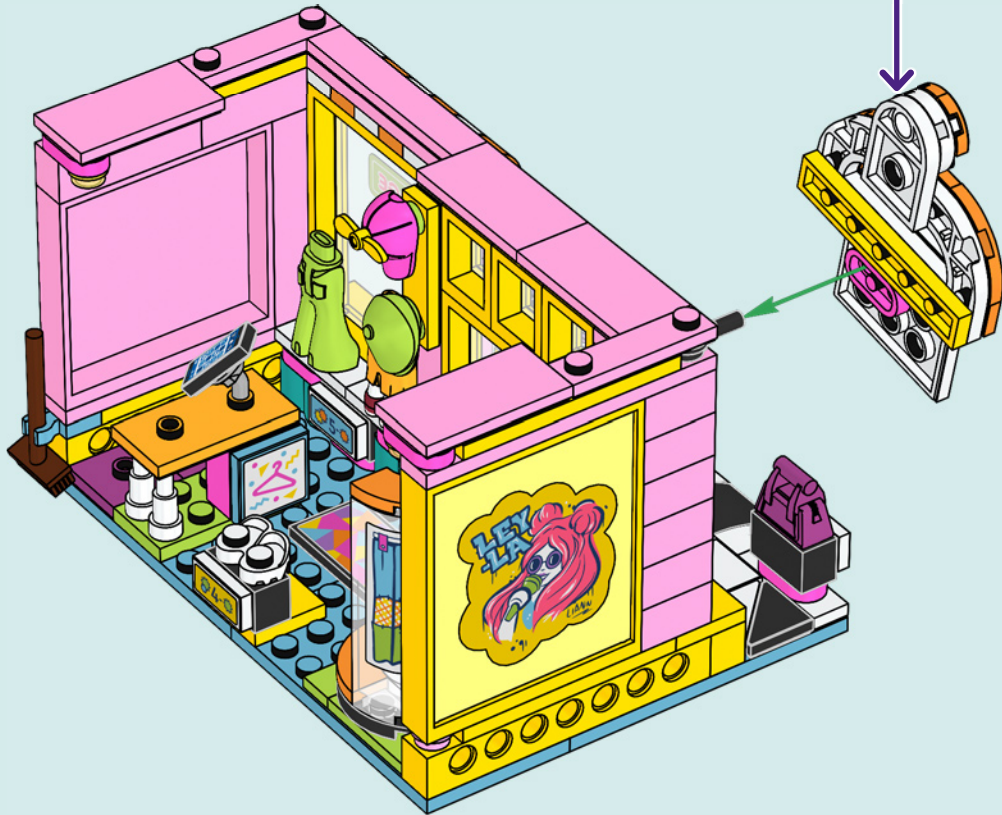

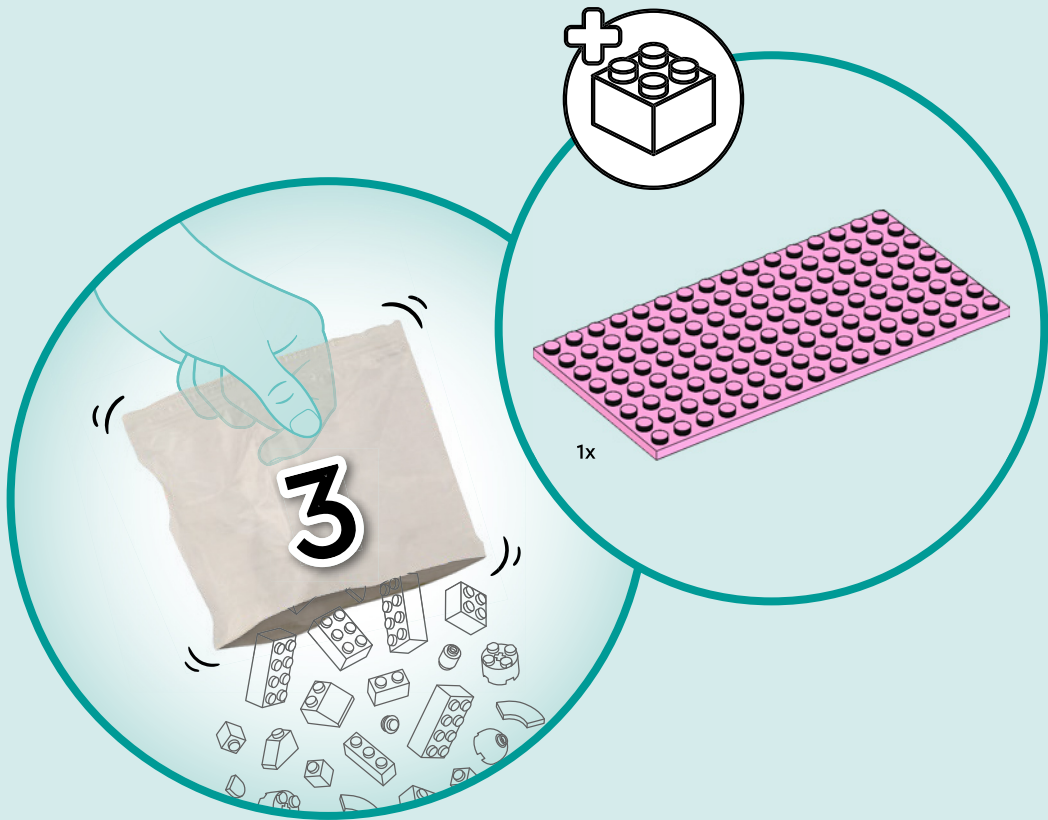



OLLY

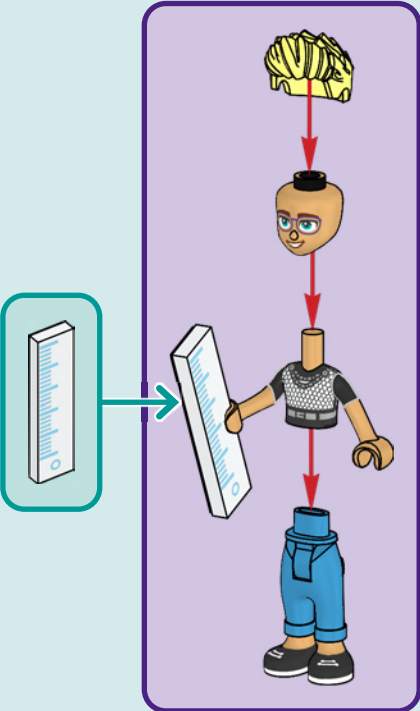

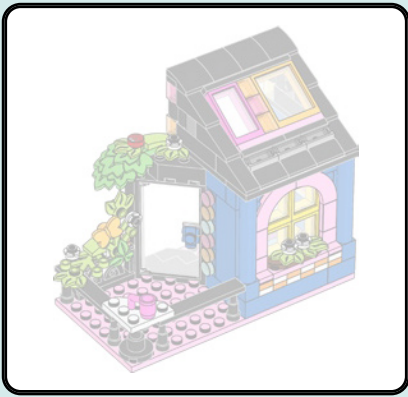

1x

77

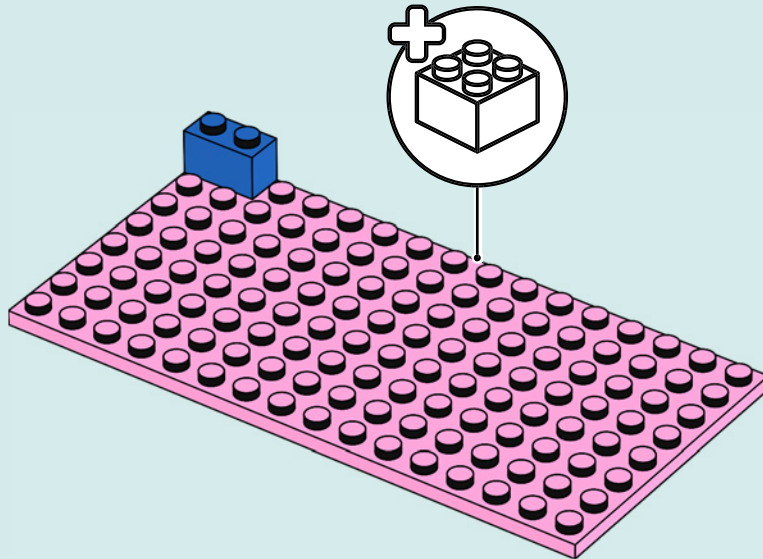

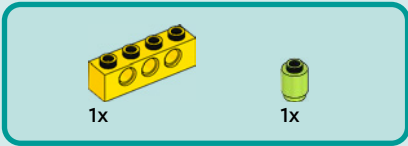

78

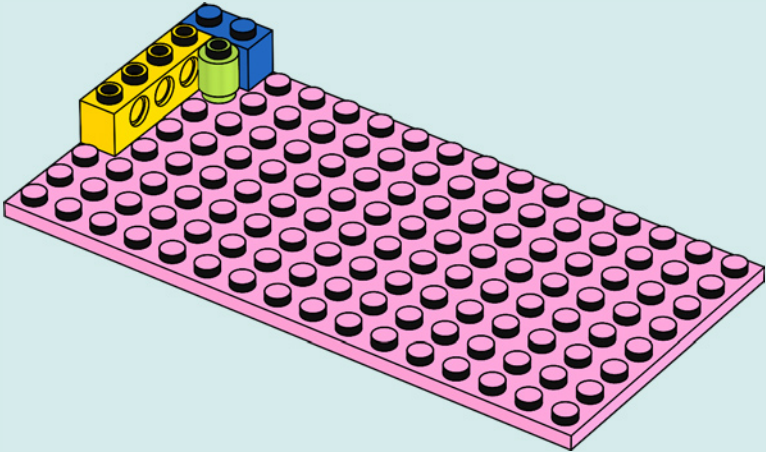

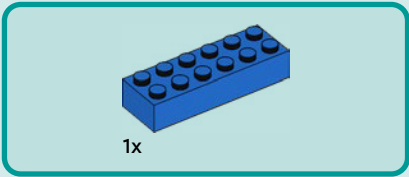

79

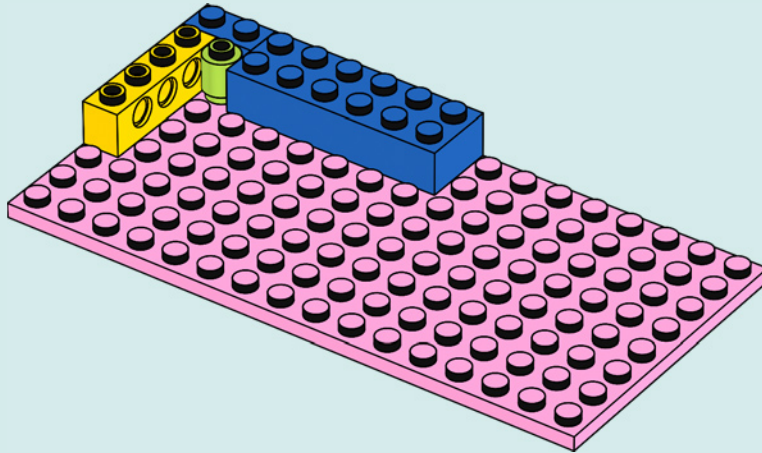

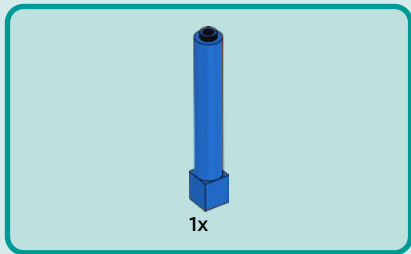

80

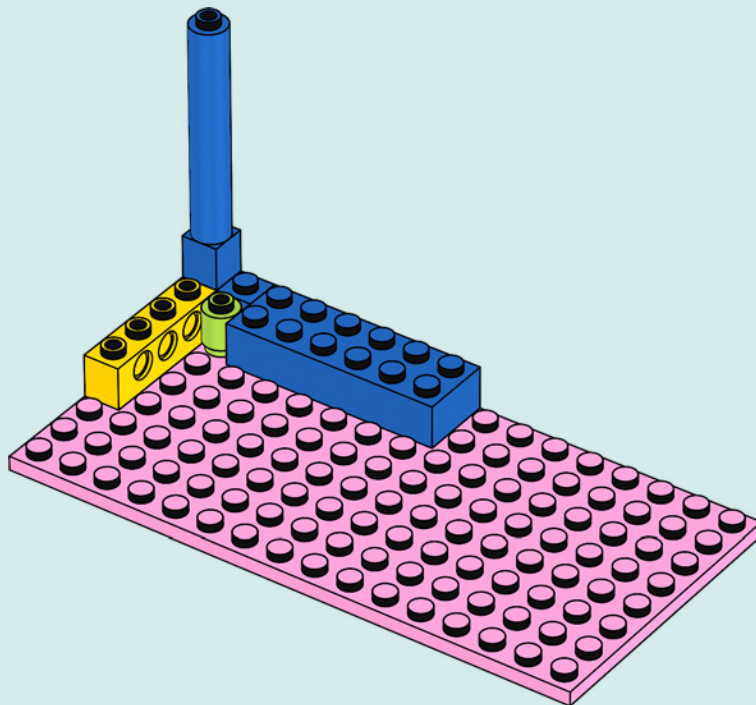

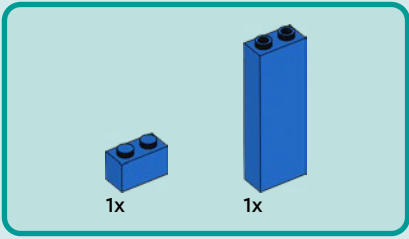

81

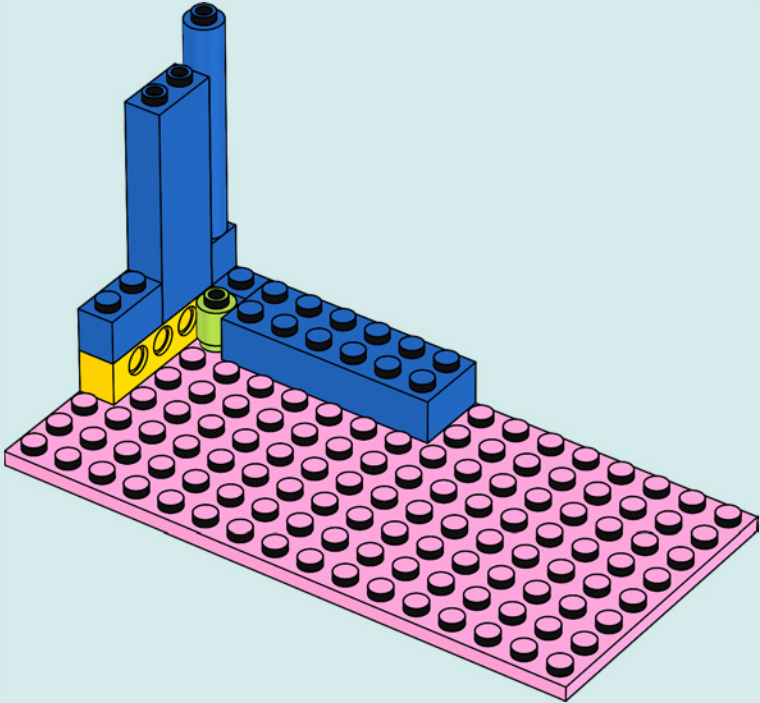

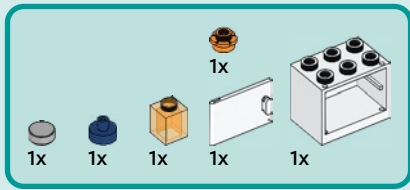

82

1

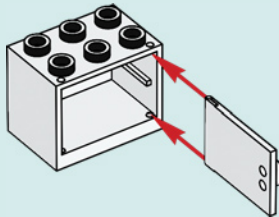

2



3

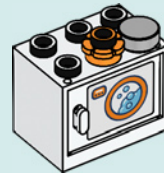

4

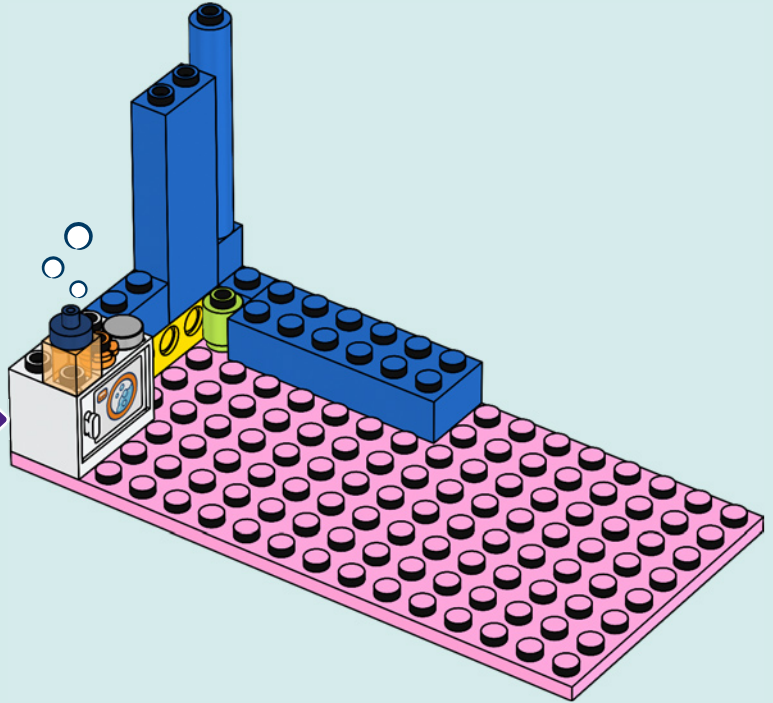

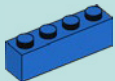

1x



1x

83

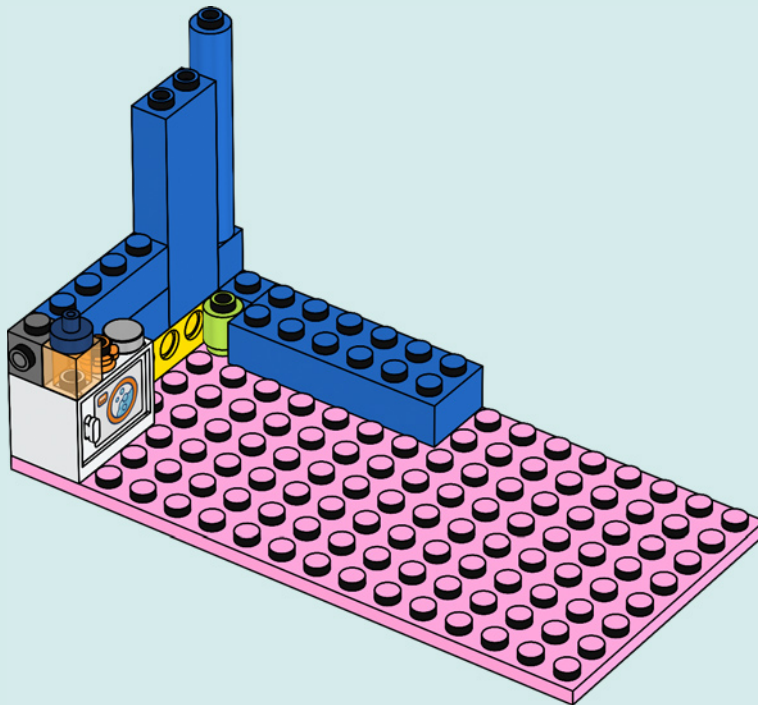

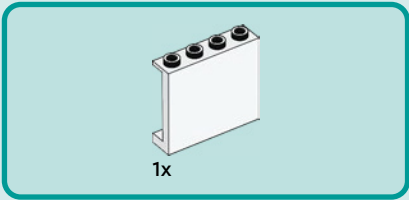

84

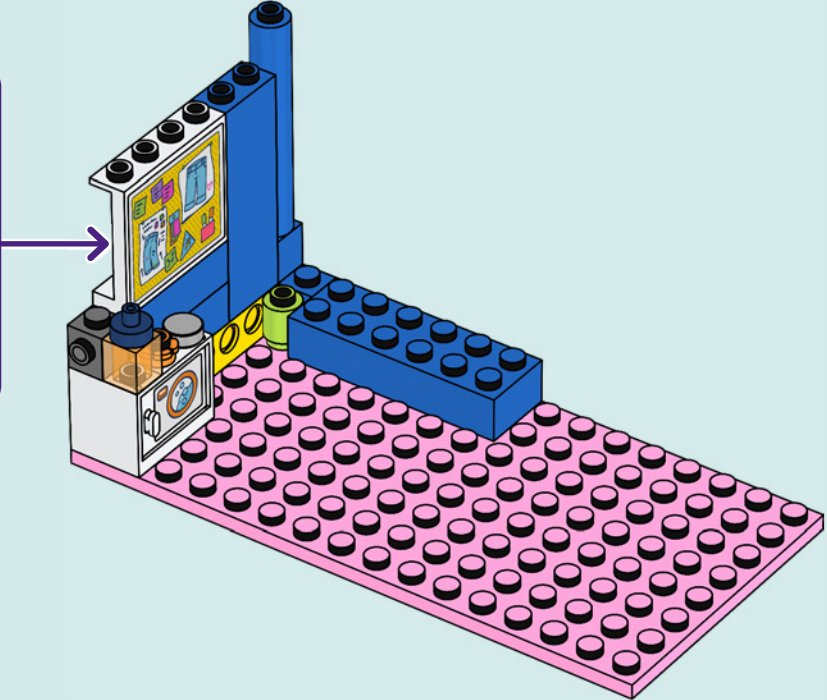
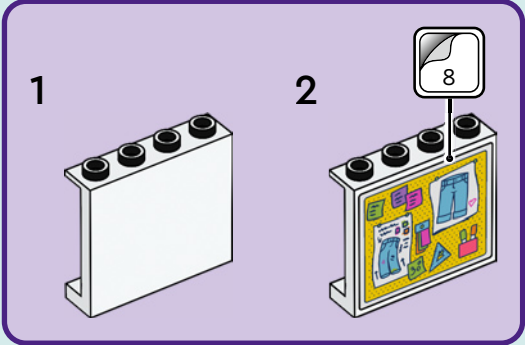



2x



1x

85

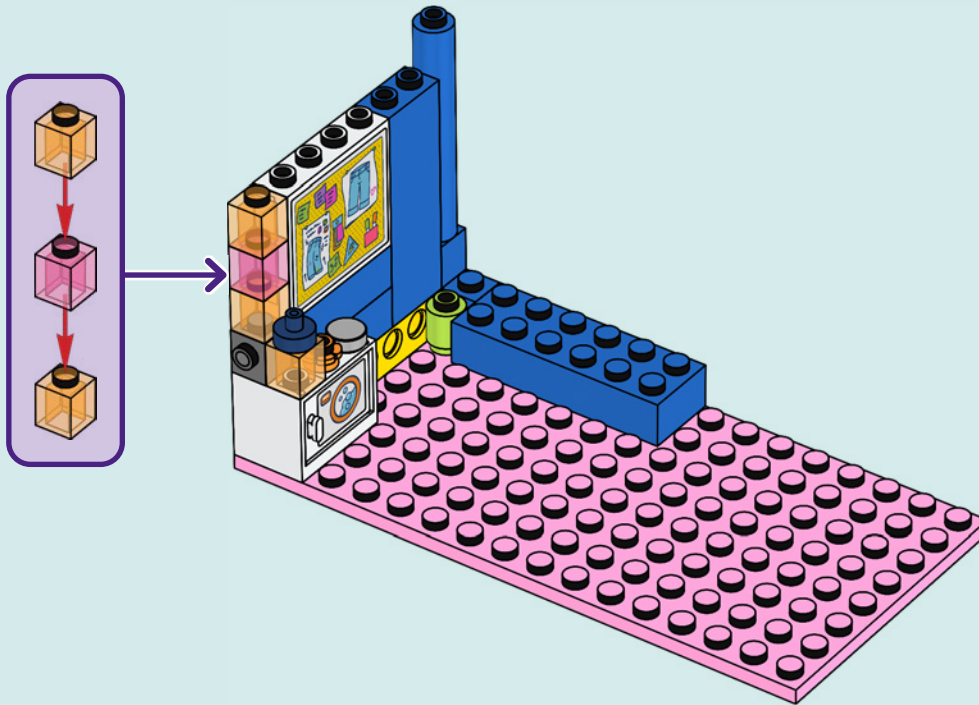

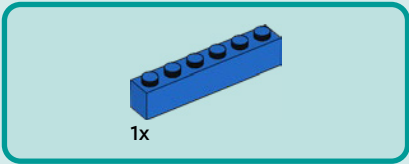

86

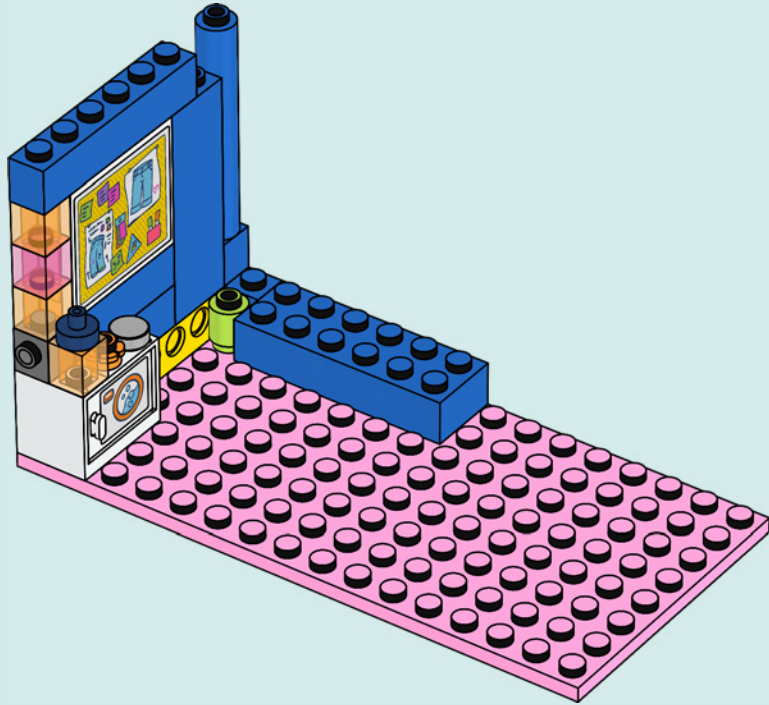



3x



3x

87

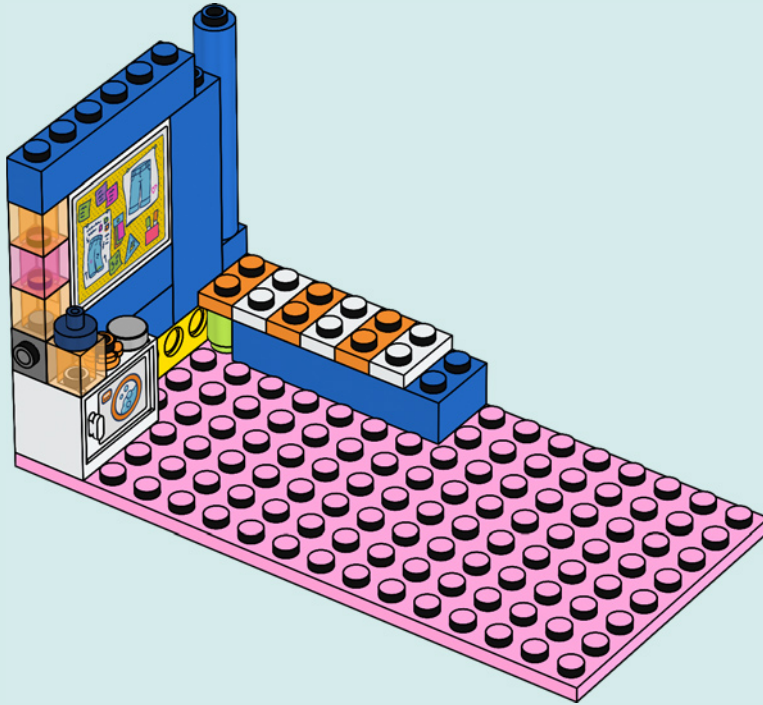



3x



3x

88

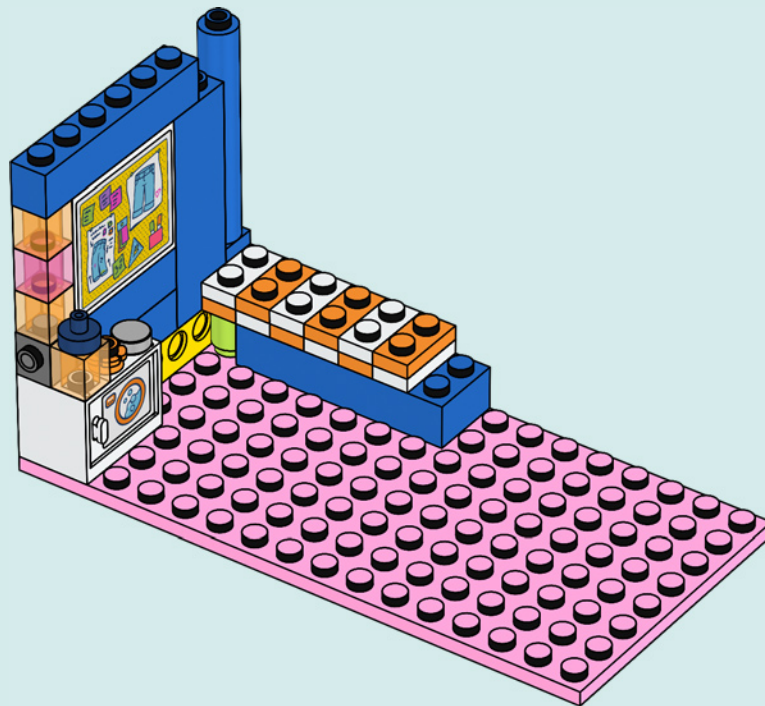

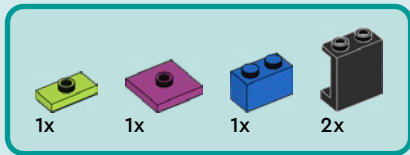

89

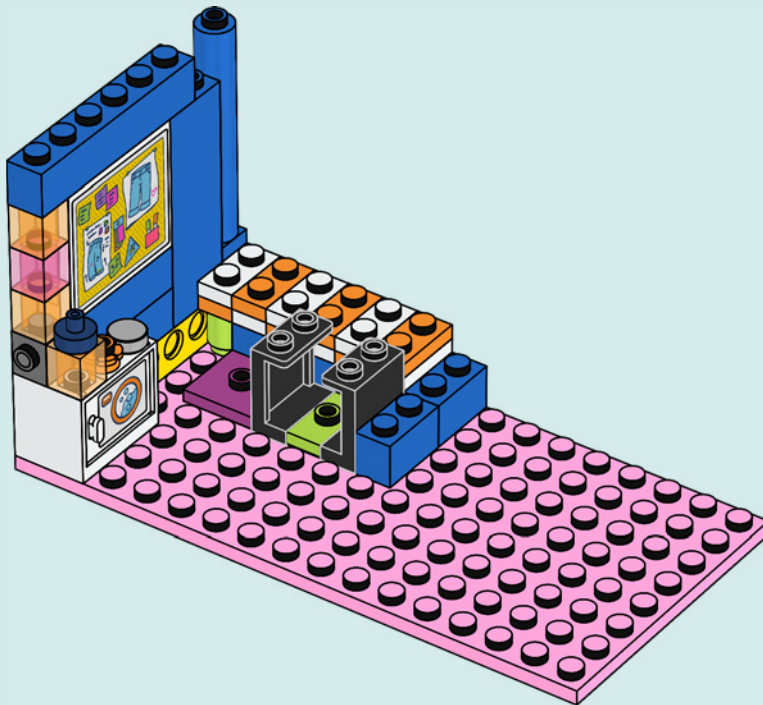

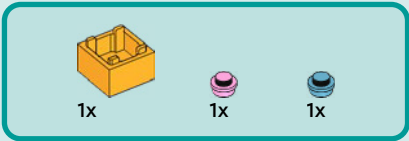

90

1

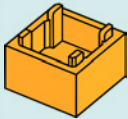

2

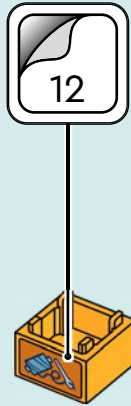

3



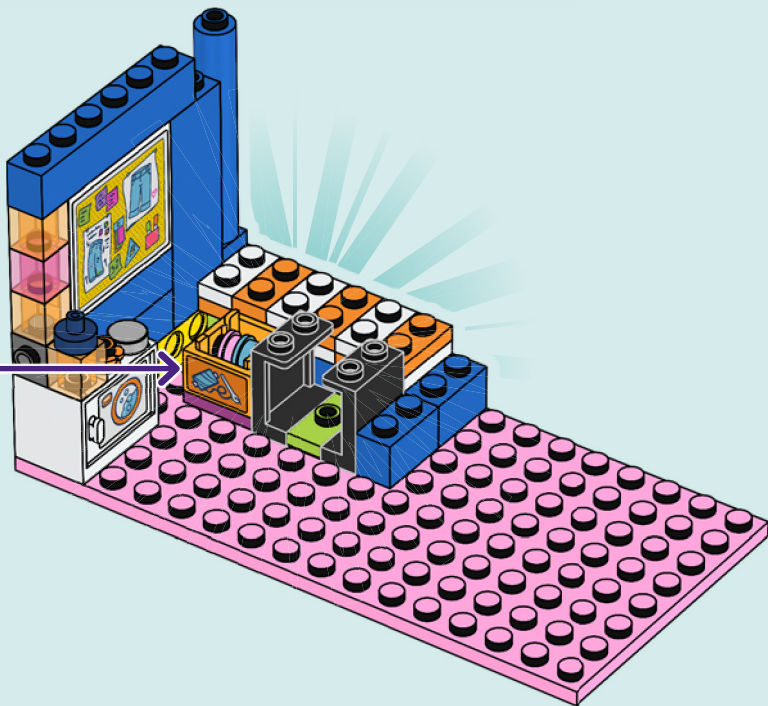

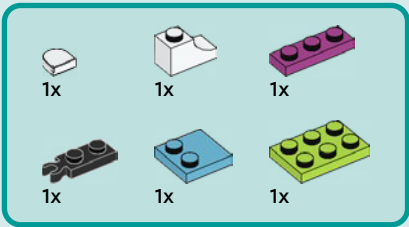

91

1

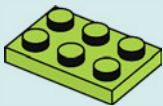

2

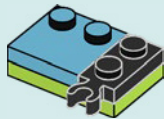

3

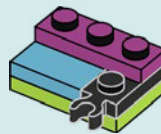

4

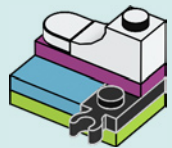

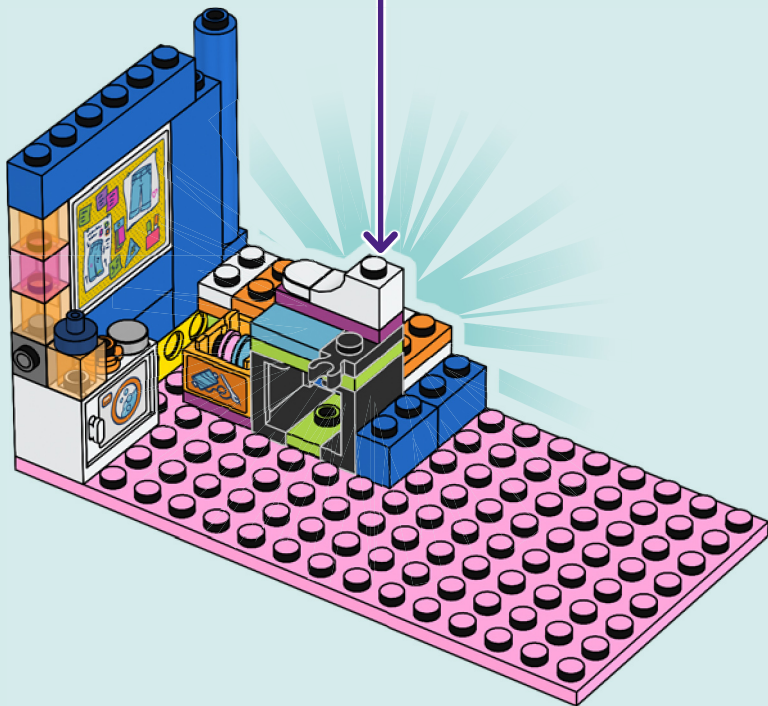

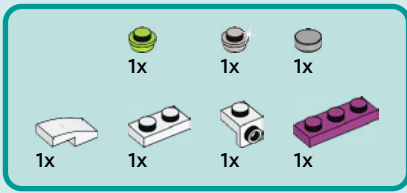

92

1

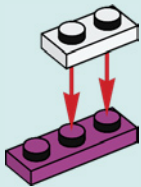

2

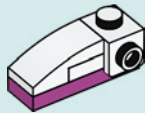

3

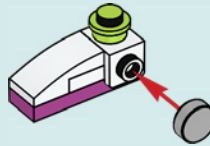

4

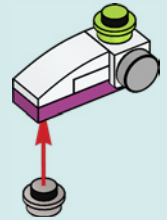

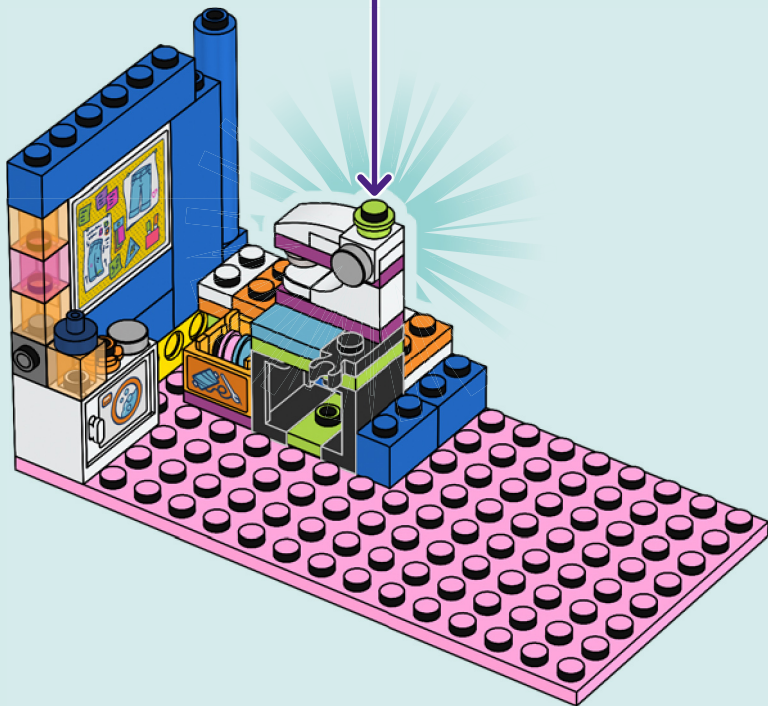

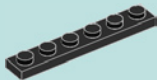

1x

93

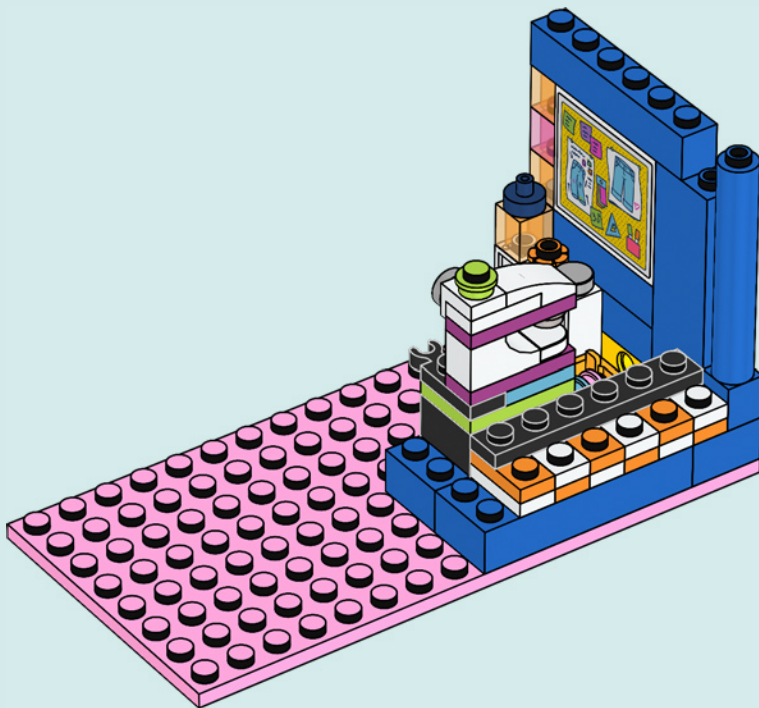
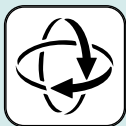



1x



2x

94

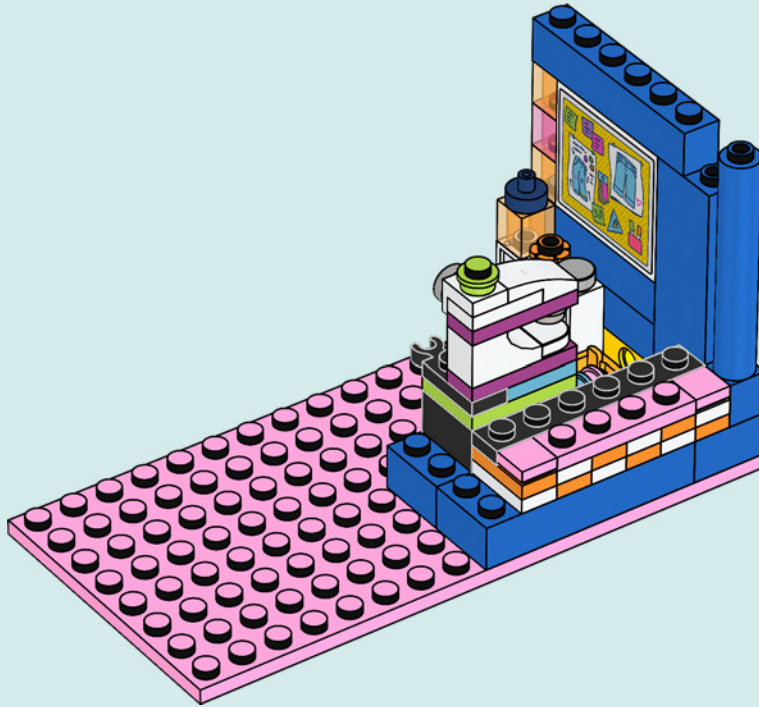

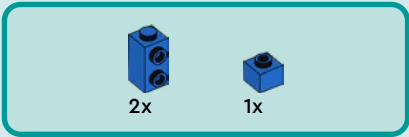

95

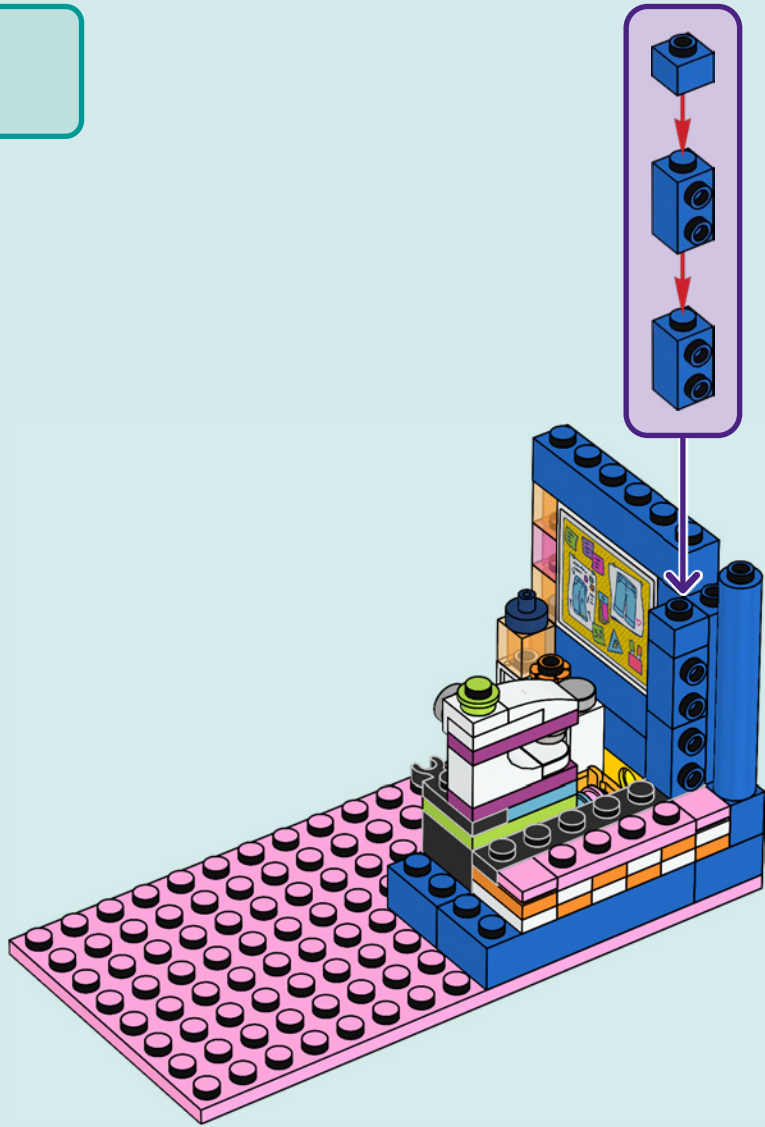

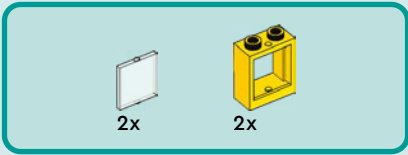

96

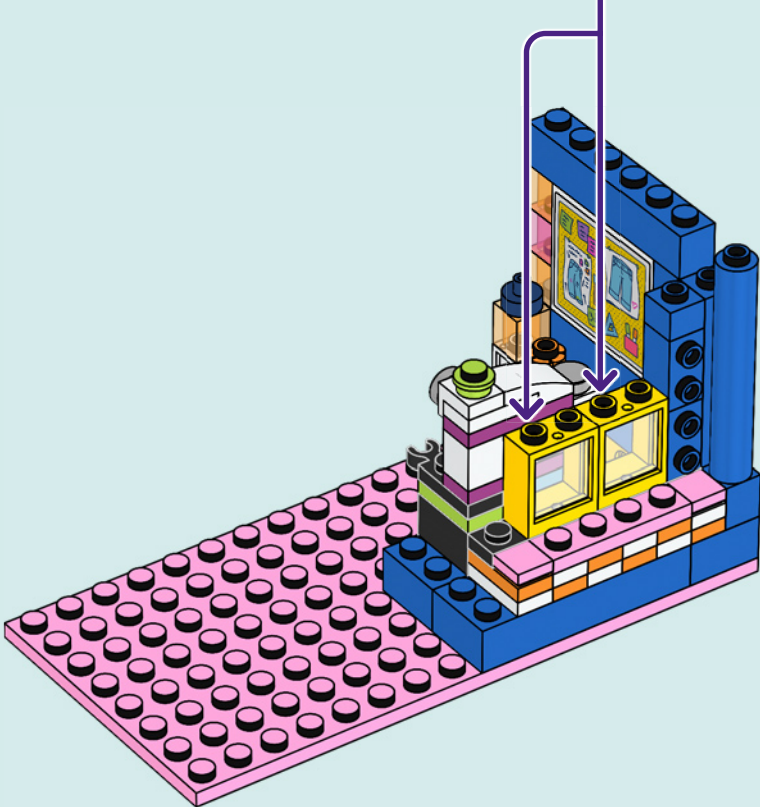
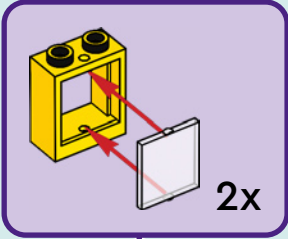

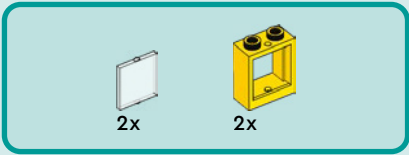

97

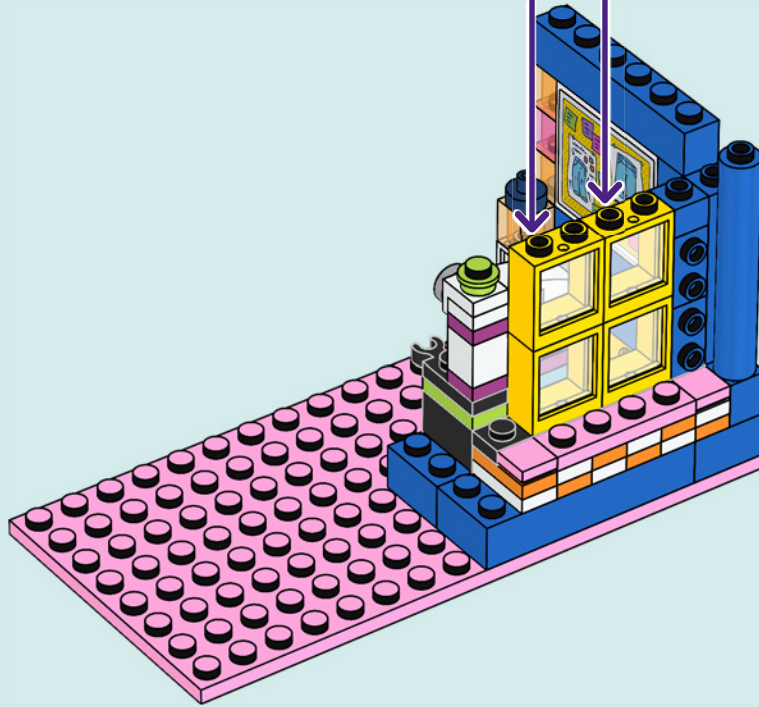
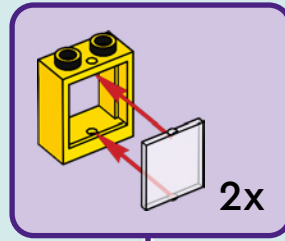



2x



1x

98

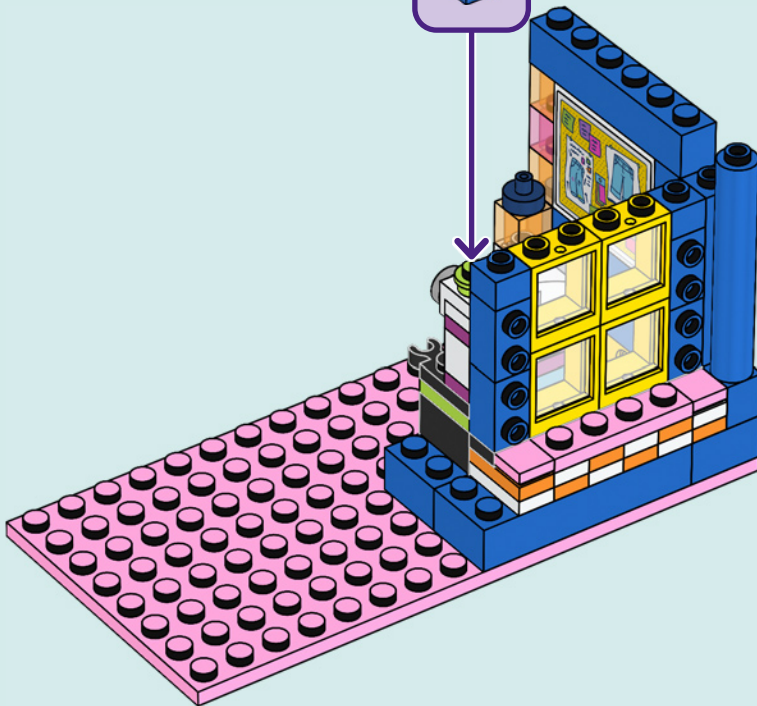
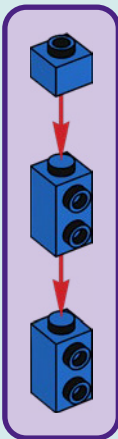



3x

99

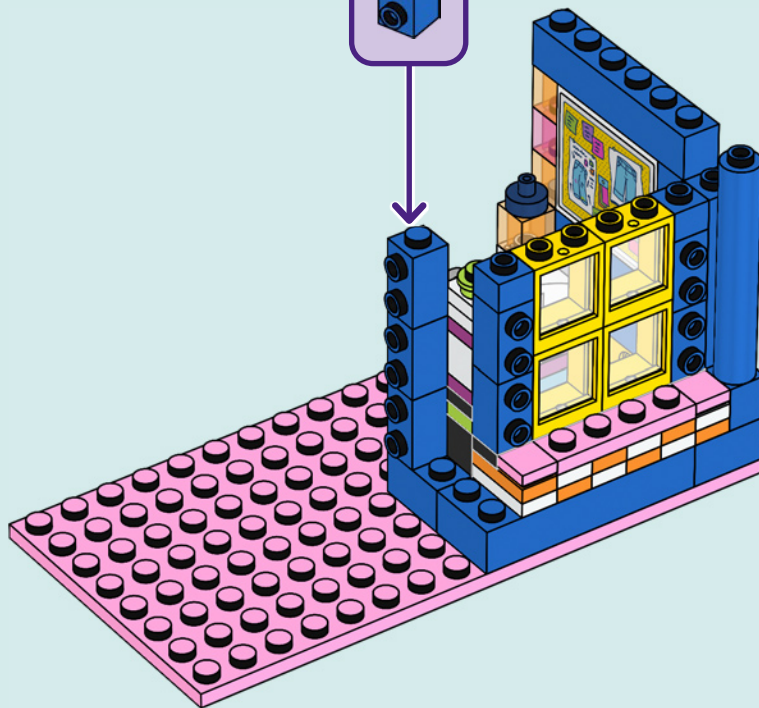
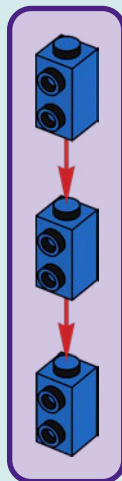

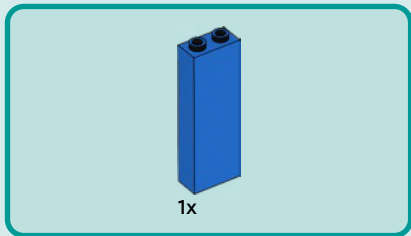

100

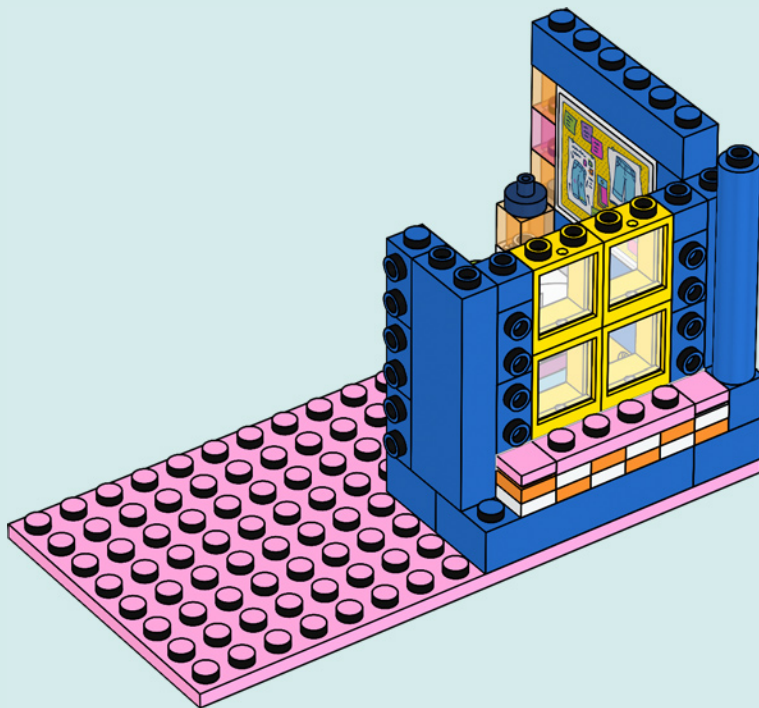

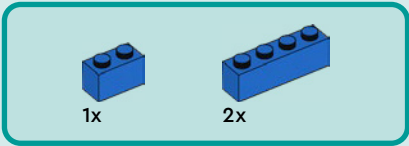

101

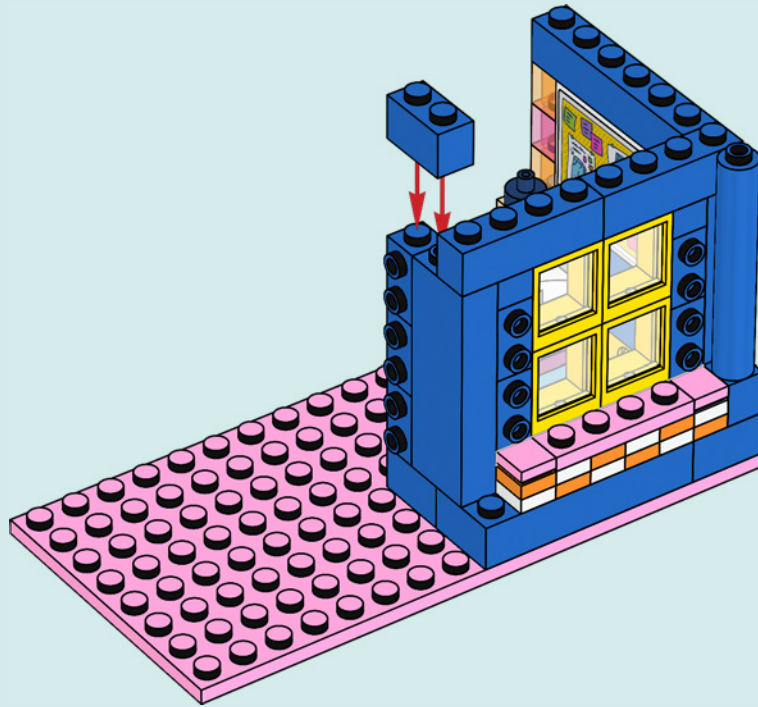

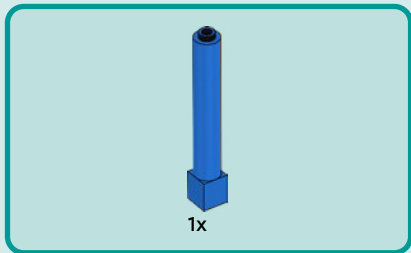

102

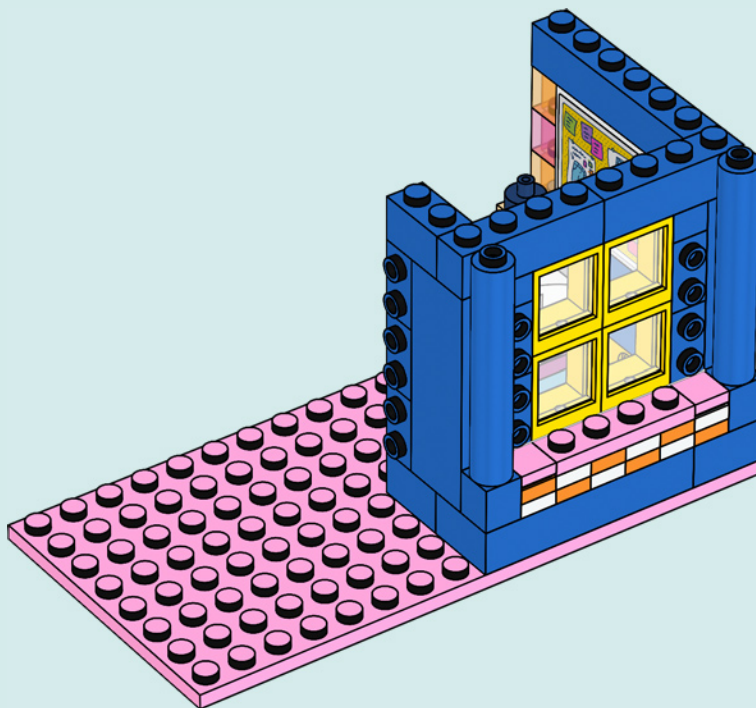

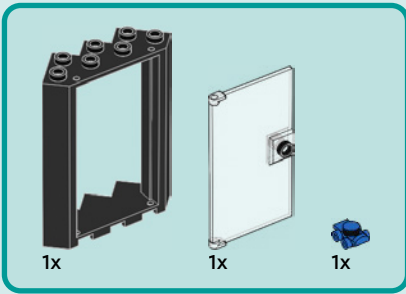

103

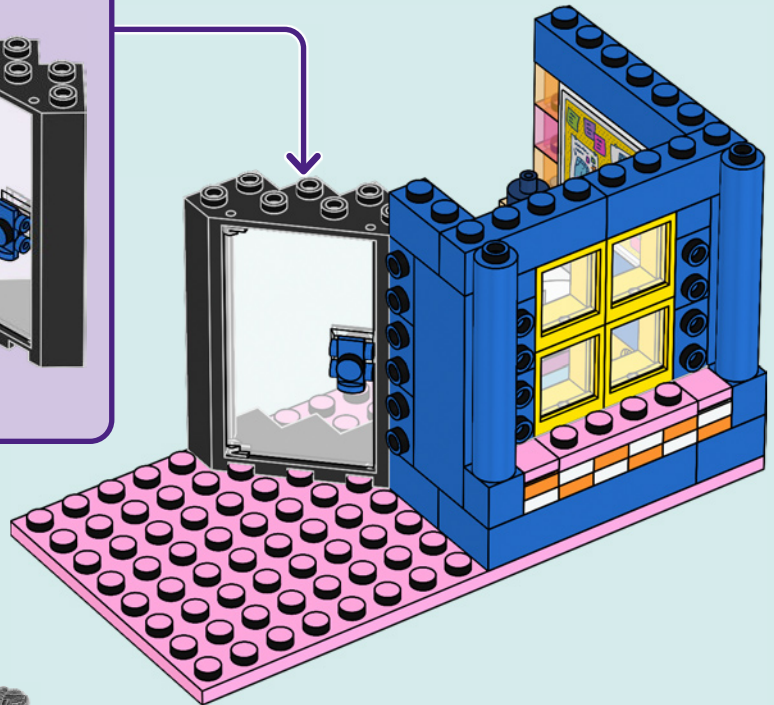
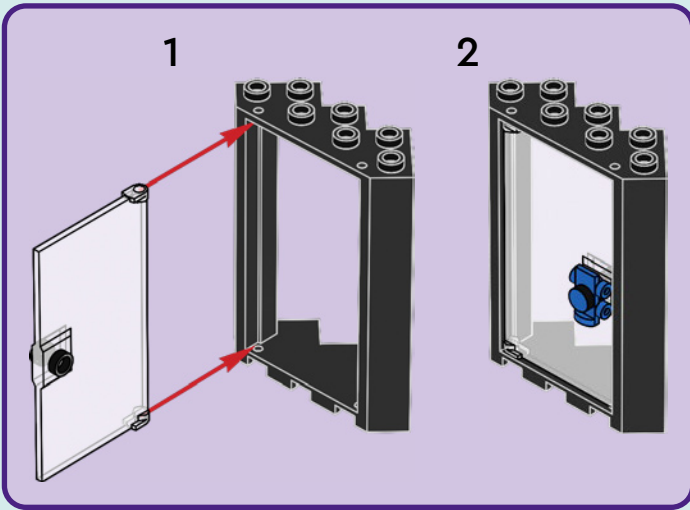

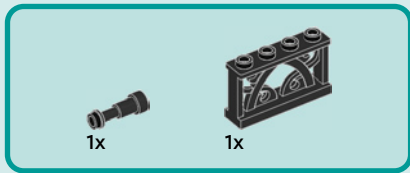

104

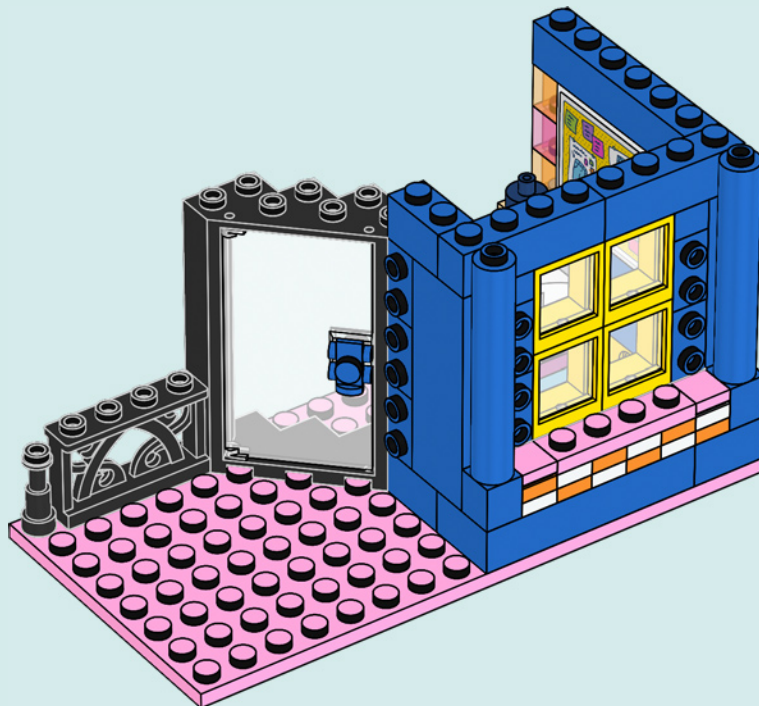

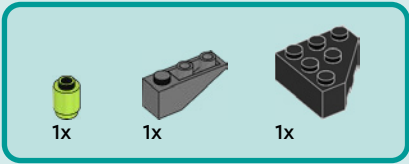

105

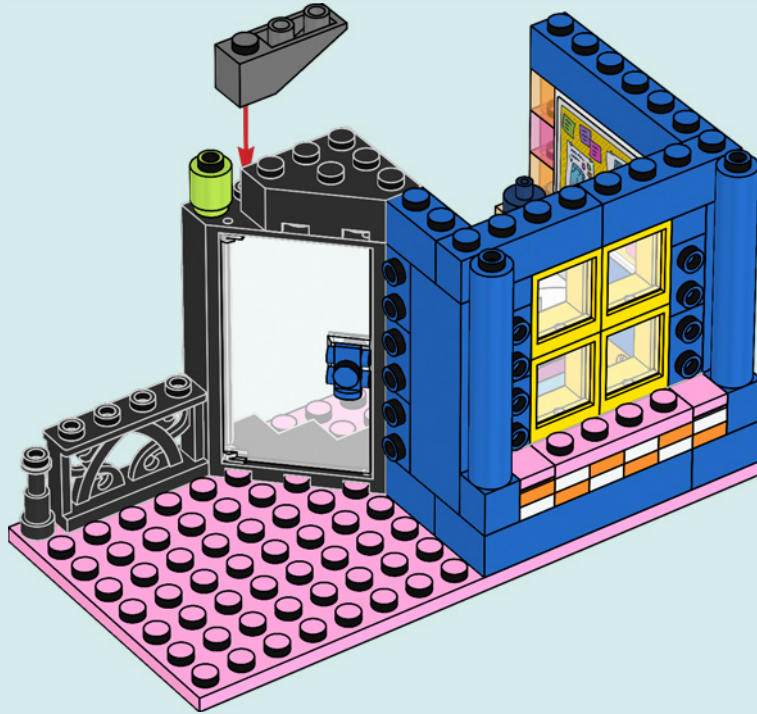

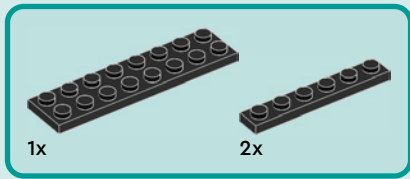

106

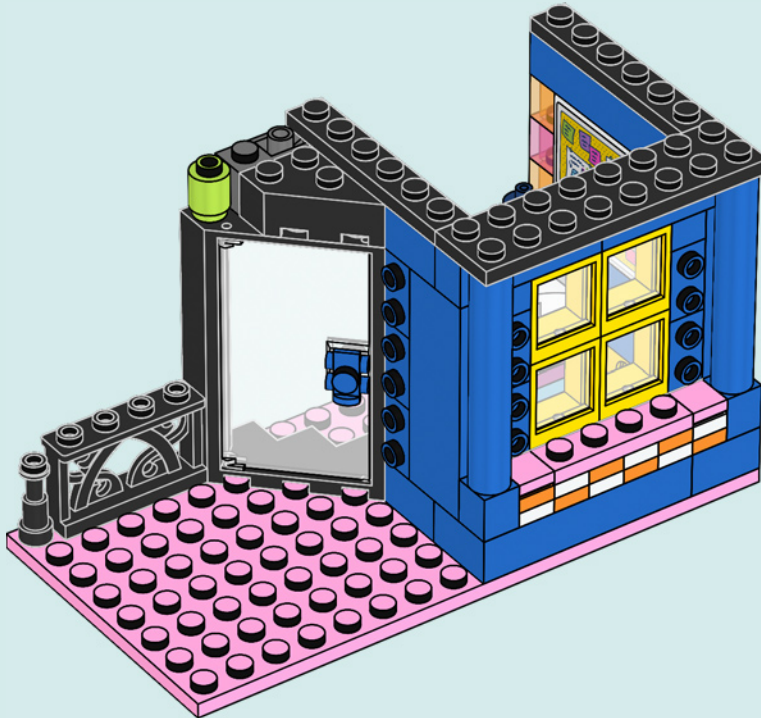

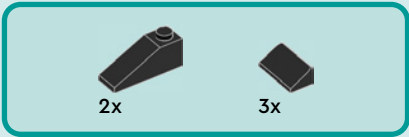

107

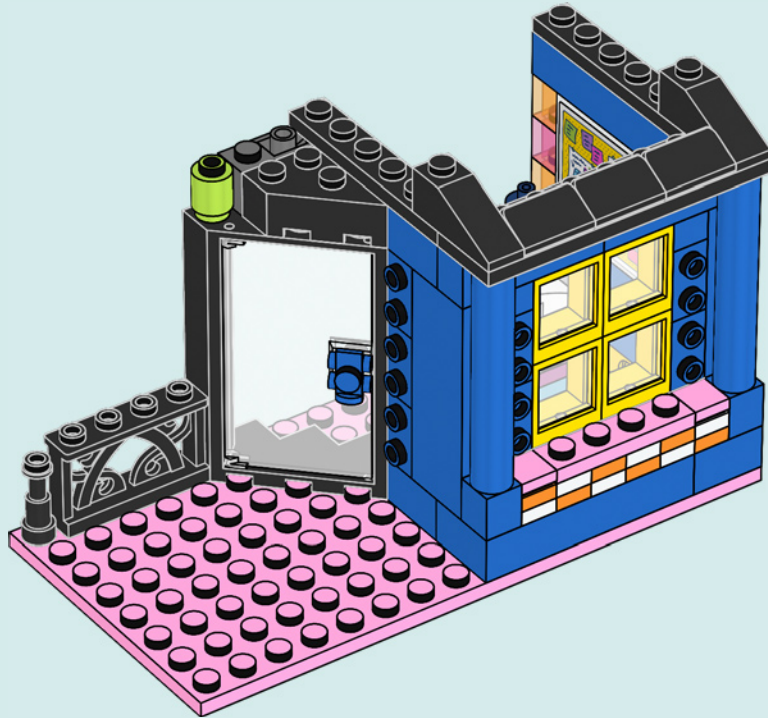

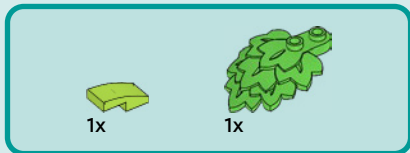

108

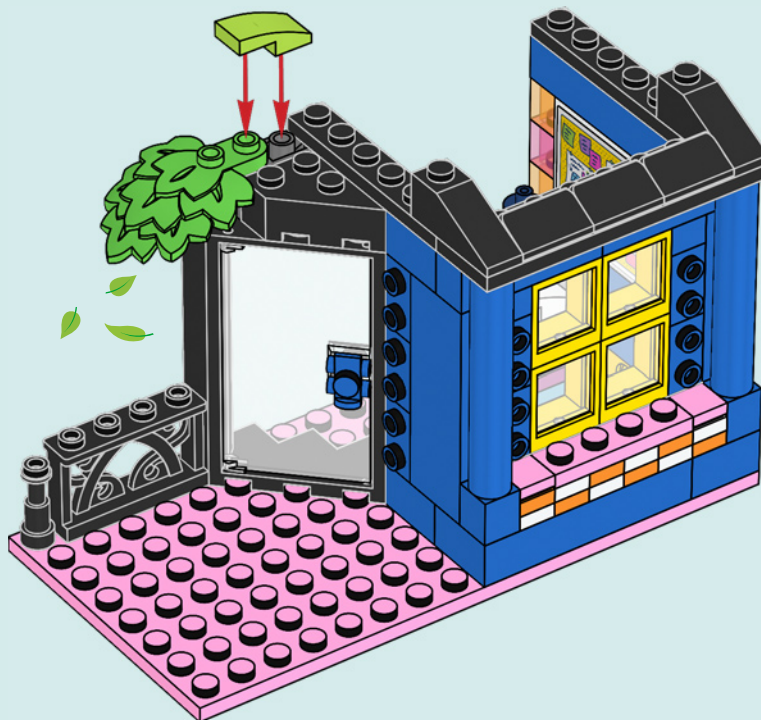



1x

109

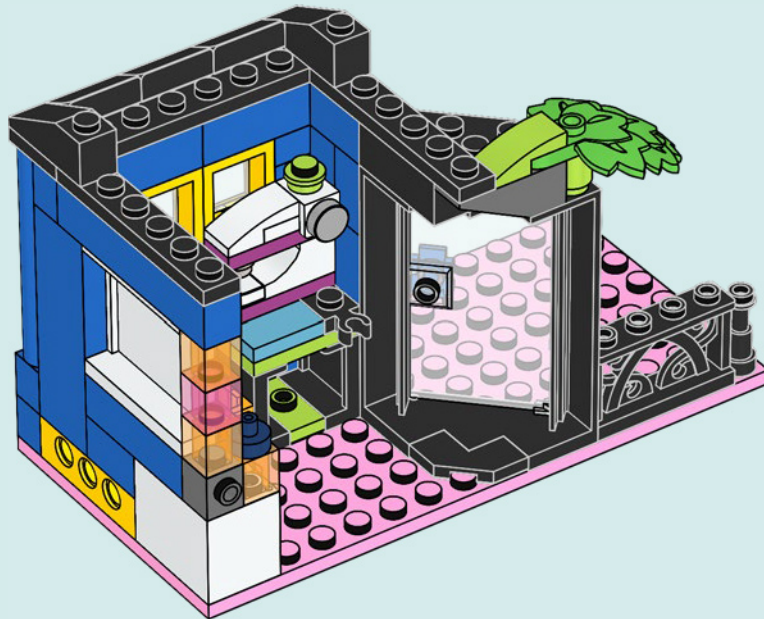



1x

110

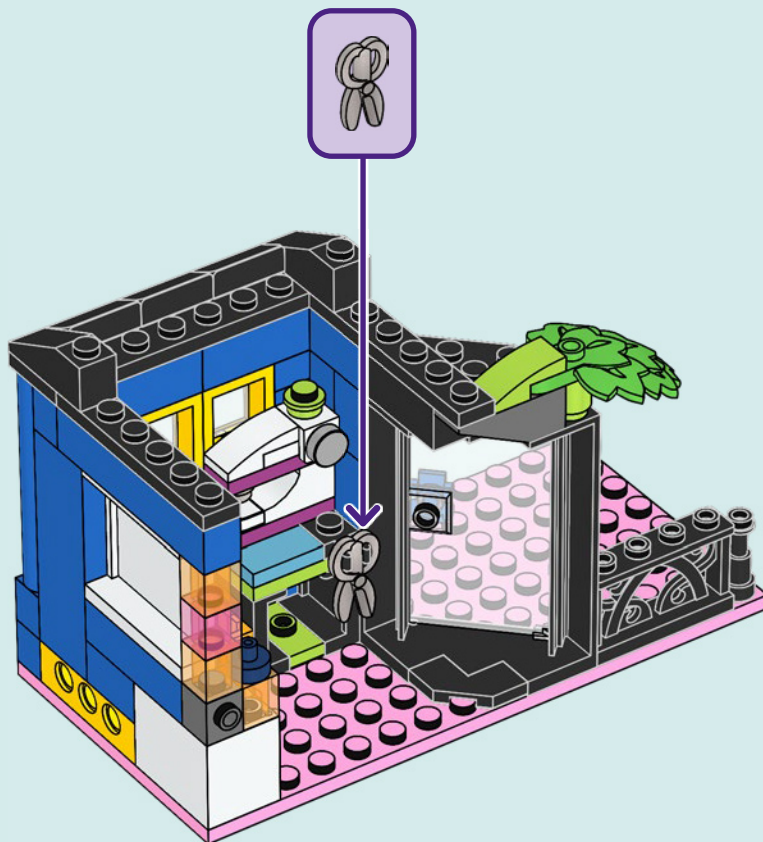



2x

111

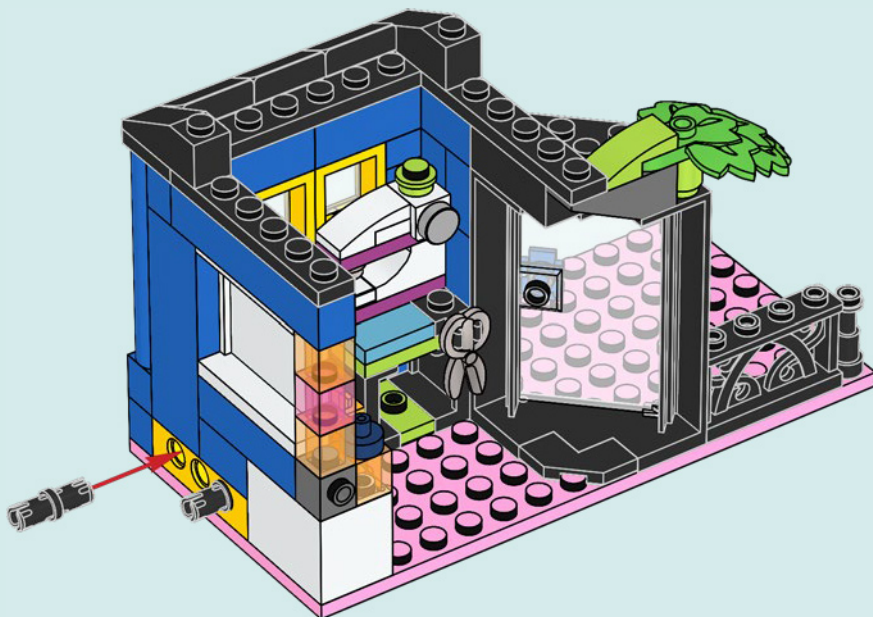

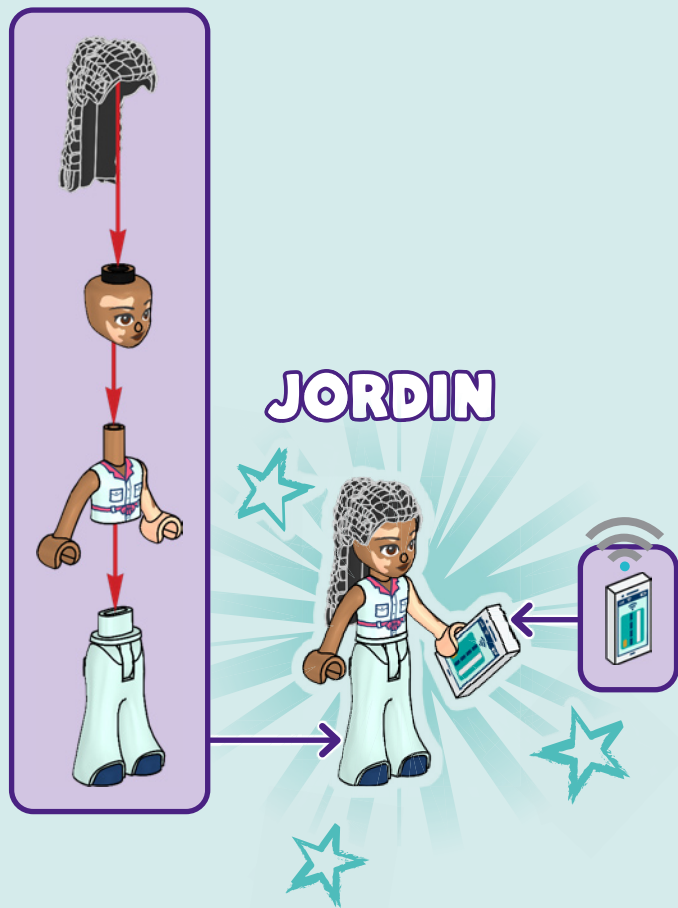



3x

112

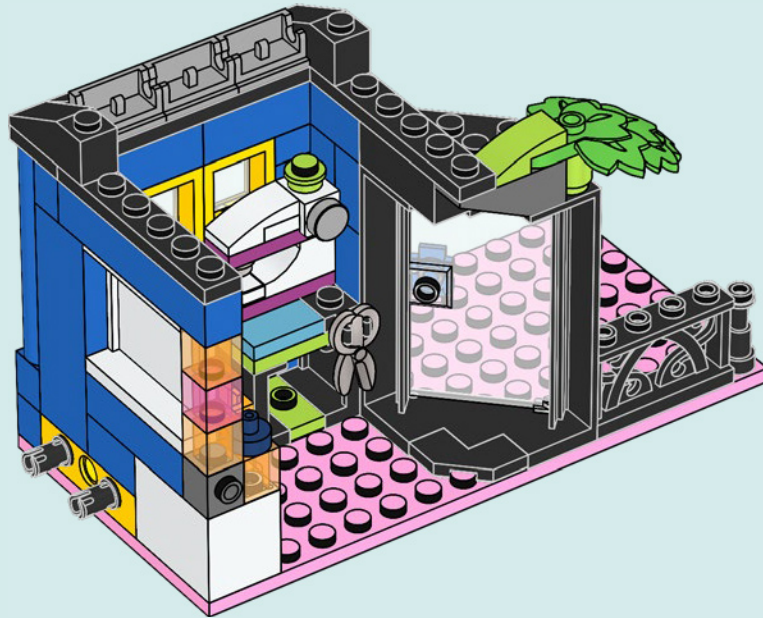



3x

113

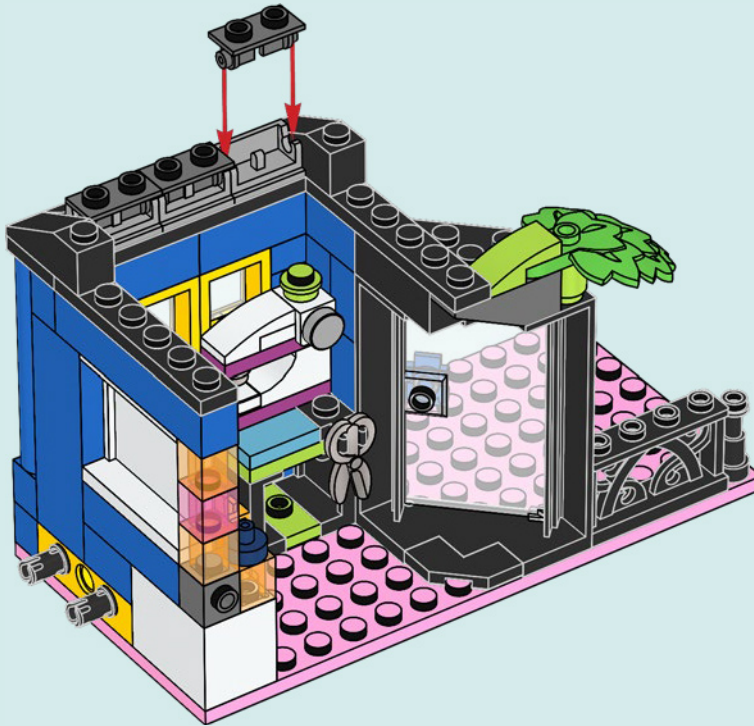



2x



2x

114

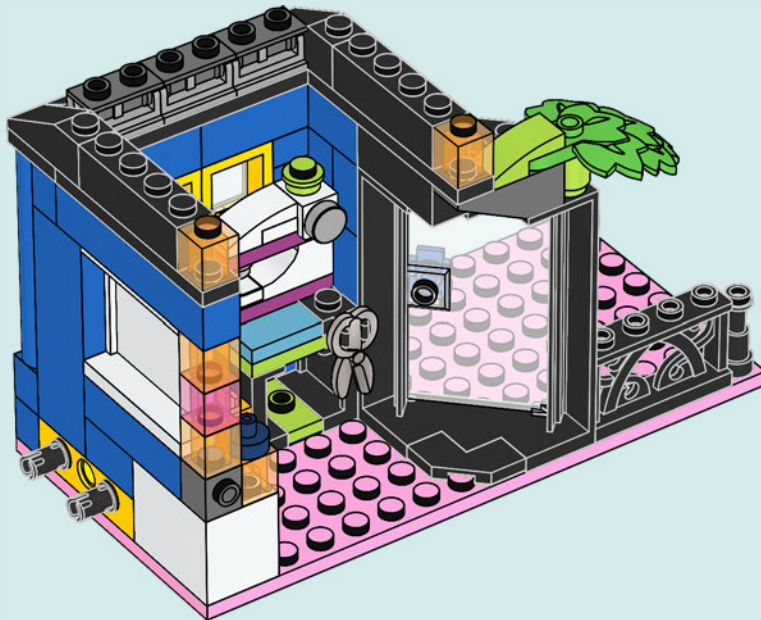



2x



2x



2x

115

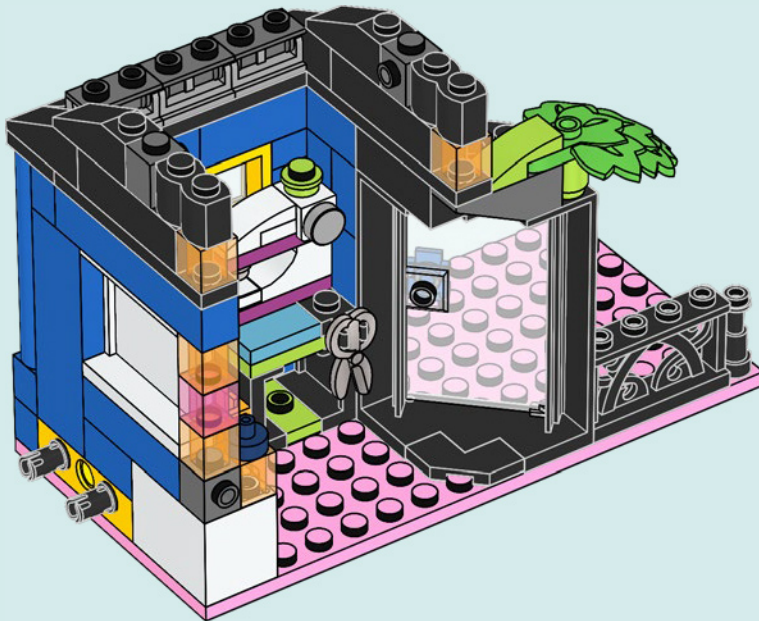



2x



2x

116

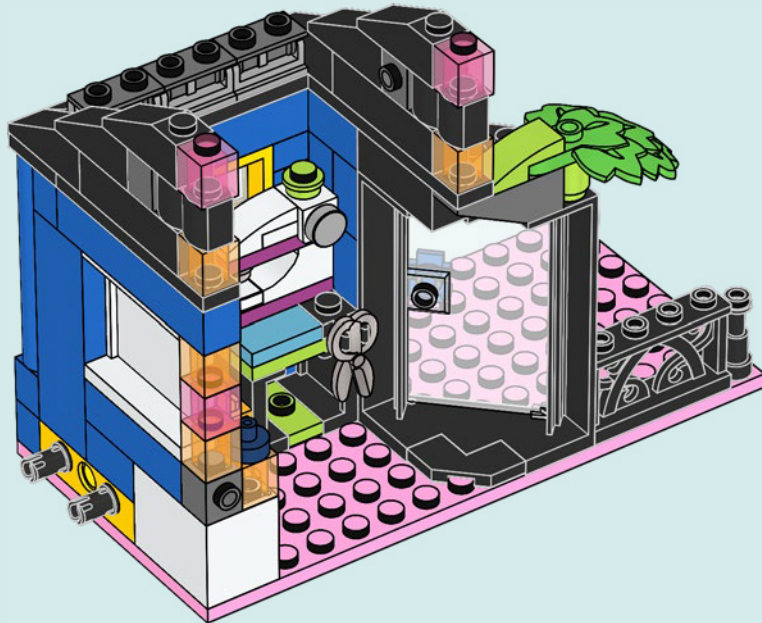

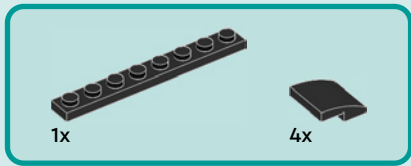

117

1

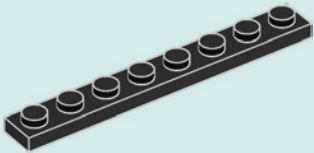

2

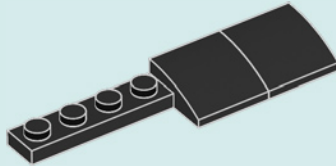

3

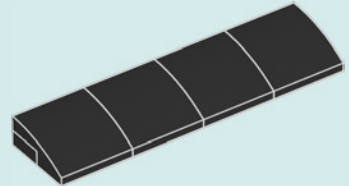

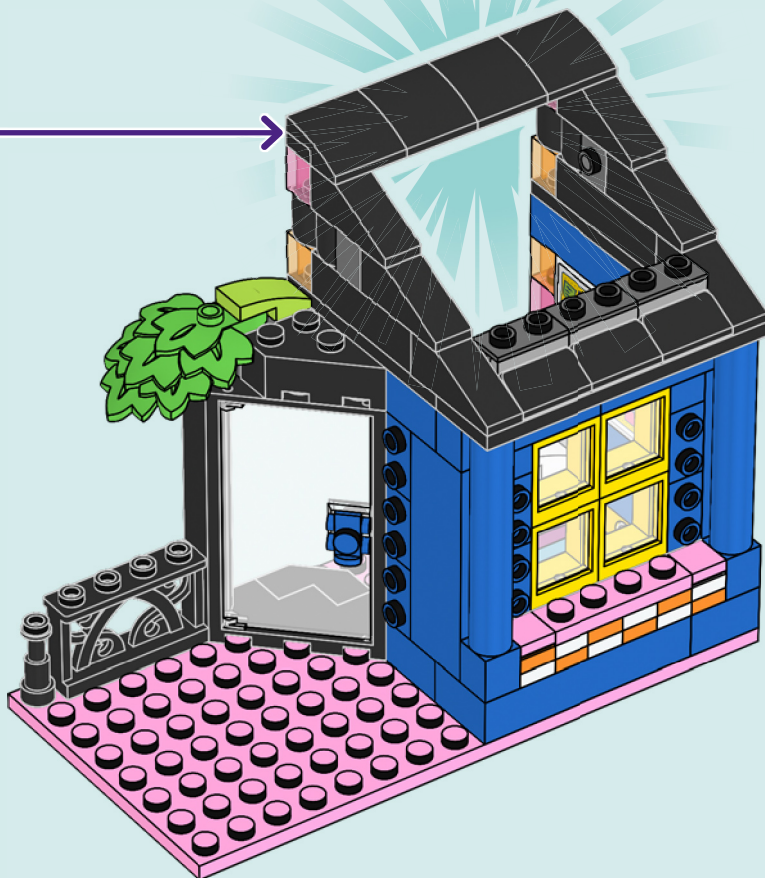



2x

118



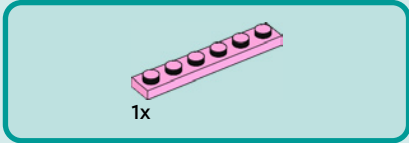
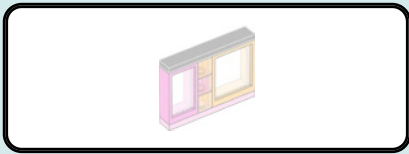

119

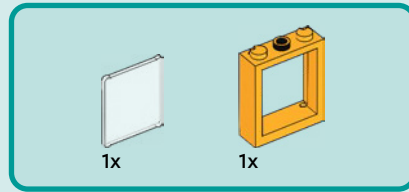
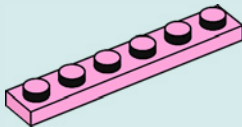

120

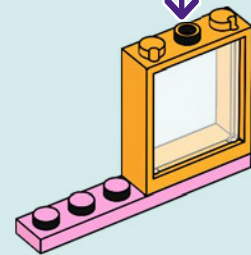
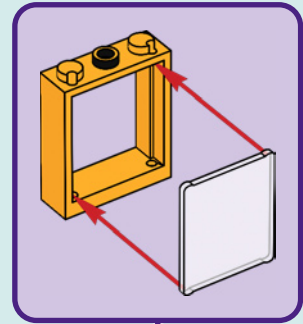



2x



1x

121

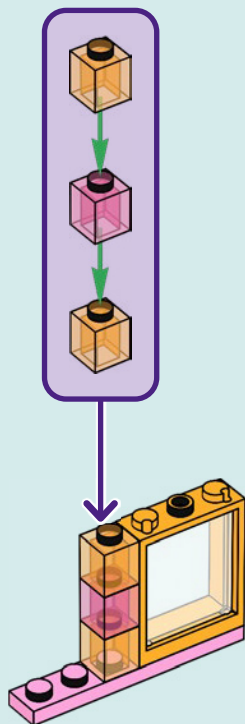

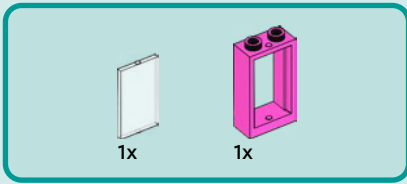

122

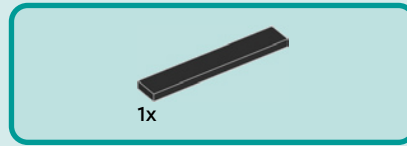
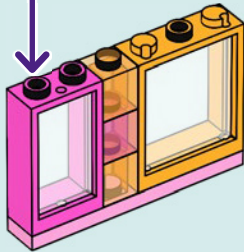
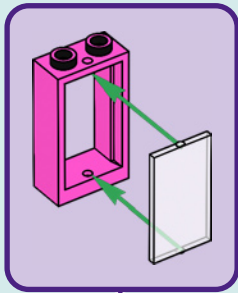

123

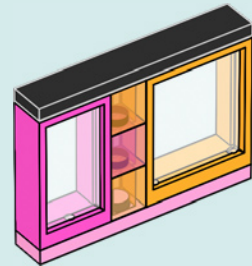

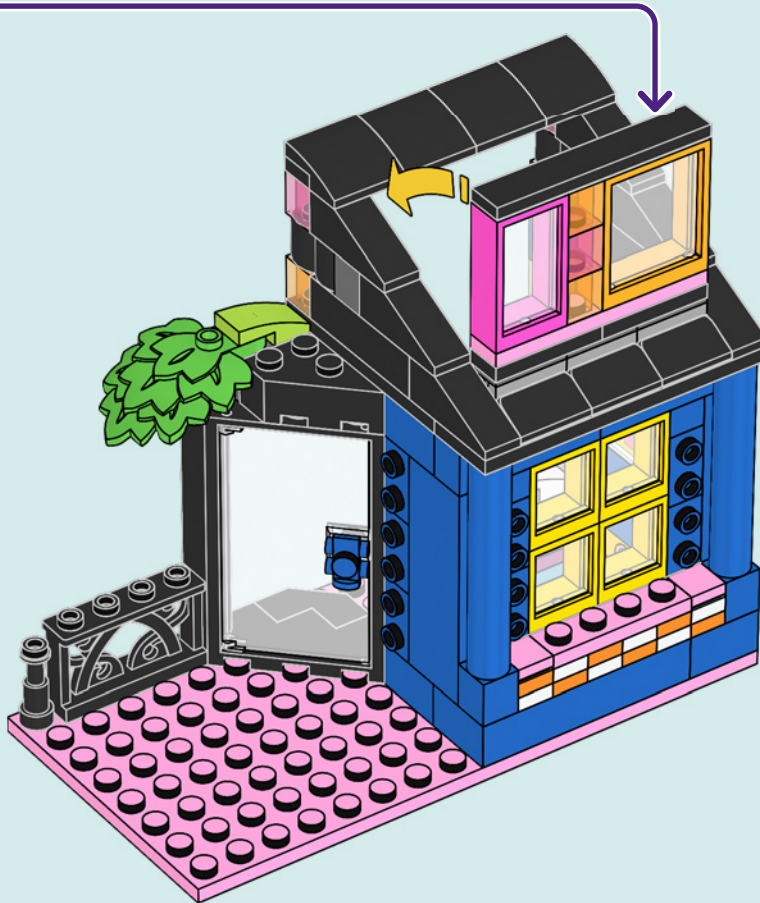



1x



2x

125

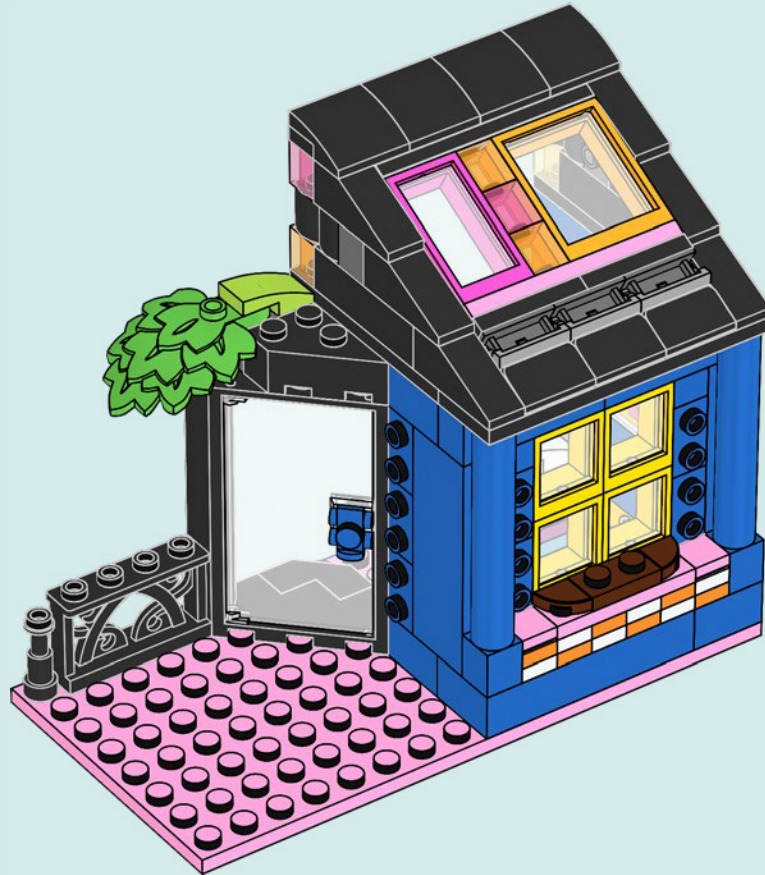



2x



2x

126

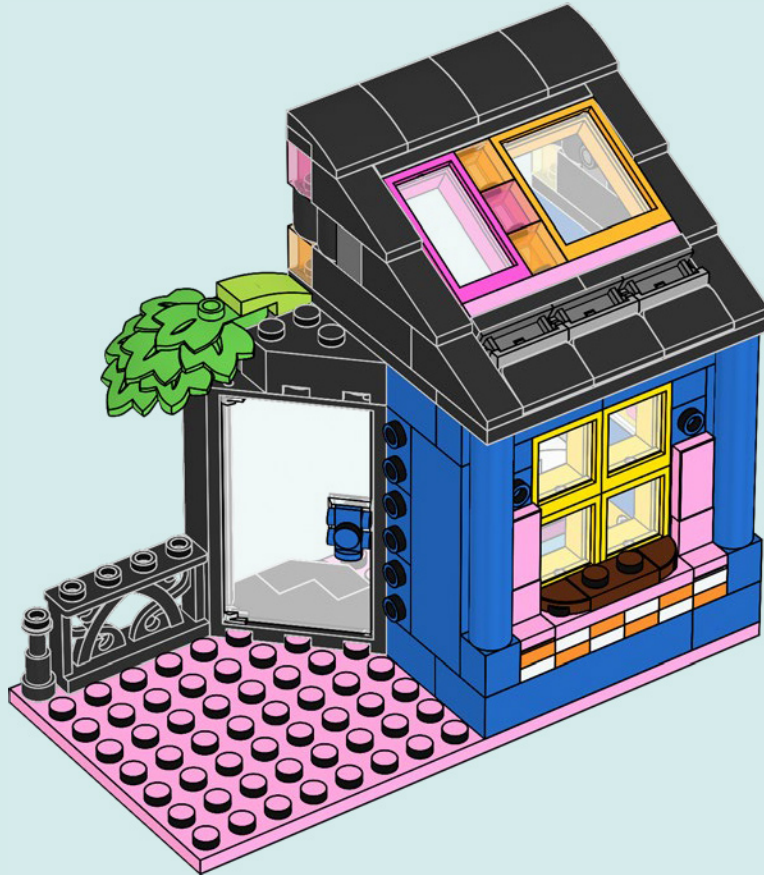



2x



2x

127

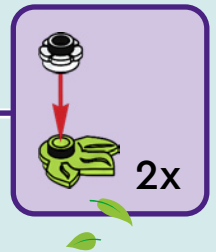
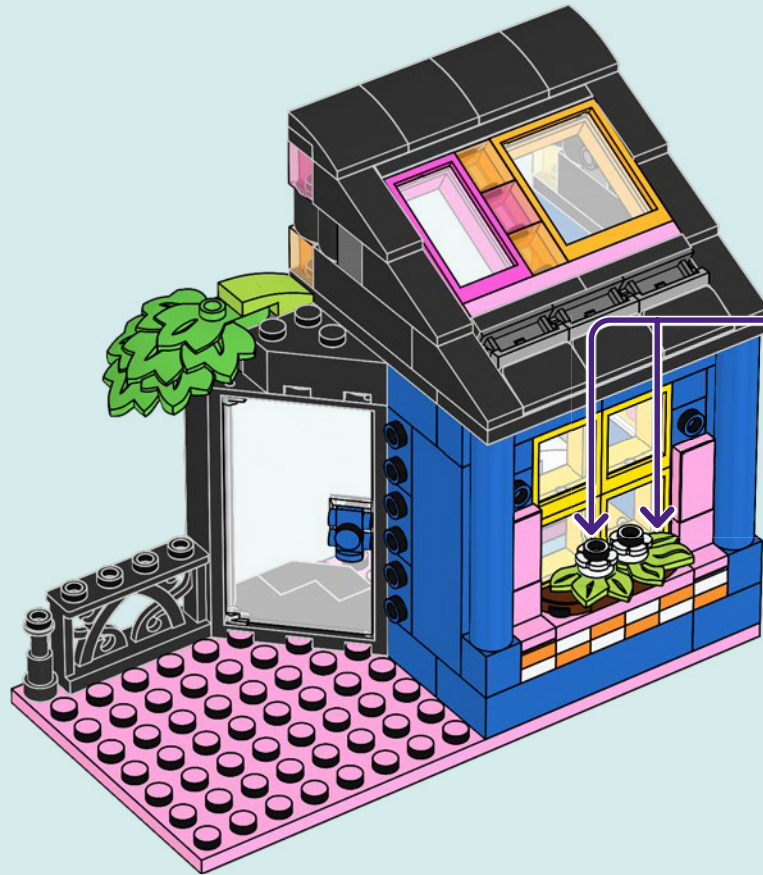



2x

128





2x



2x



2x

129





1x

130





3x

131





2x

132





1x



1x

133

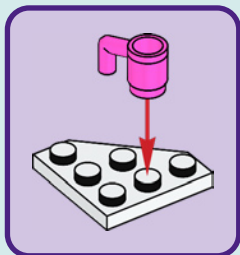



1x



1x

134



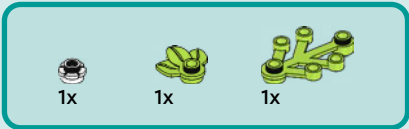

135

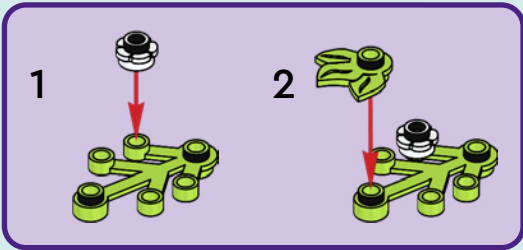



1x

136



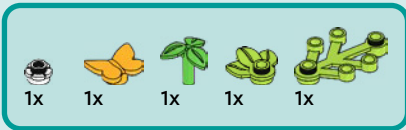

137

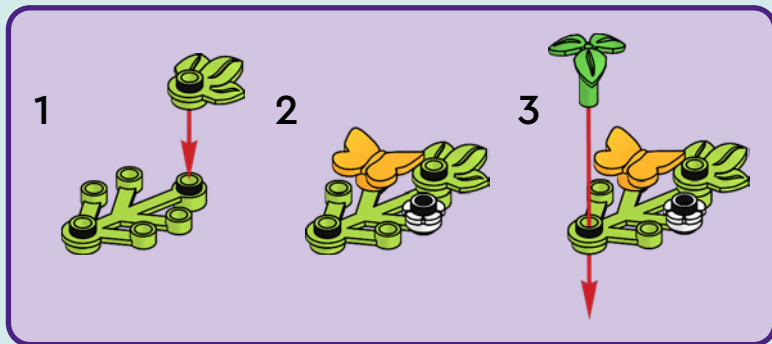



1x



1x



2x

138



139





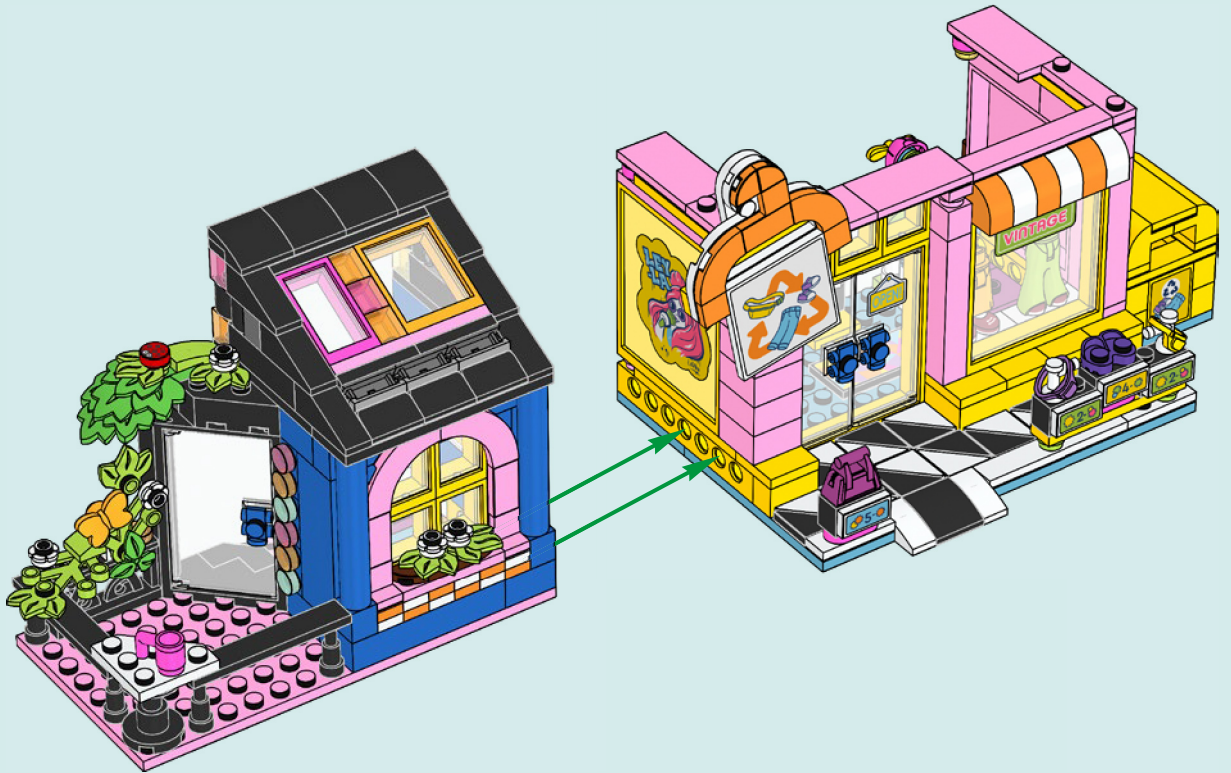





Friends

NOVA

OLLY

ALIYA

PAISLEY

ZAC

LIANN

LEO

AUTUMN





Friends



42620



42617



42606



42604



42619



Friends



REGARDEZ
LA SÉRIE
EN LIGNE

MIRA
LA SÉRIE
EN INTERNET

WATCH
SERIES
ONLINE





1x
6324417



2x
6240216



1x
6214234



5x
6206149



1x
6250591



1x
6446788



3x
459901



1x
6296132



1x
6472137



2x
403201



7x
302301



1x
6346616



4x
6195371



6x
306901



3x
6285777



3x
6034044



1x
6416469



2x
6070327



1x
4261470



11x
6217875



1x
6238334



1x
245001



1x
6089696



1x
4619665



1x
4558208



1x
371001



1x
6466346



2x
6339103



1x
663601



1x
6400128



3x
6267163



2x
6350345



7x
6290531



2x
6432005



4x
300423



2x
6055104



3x
301023



1x
300923



1x
4181139



2x
300524



1x
6457959



1x
6265497



2x
300424



7x
6424329



1x
4121625



6x
6224666



2x
362224



2x
362324



3x
370124



4x
6257598



2x
4204625

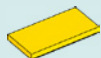

1x
4560181



6x
366624

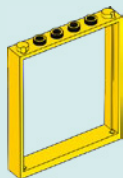

3x
6424331

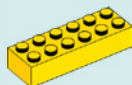

1x
4181143

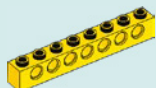

2x
370224



1x
6232135



1x
6175367



1x
6235080



1x
6457953



1x
6416645



1x
6371960



1x
6196548



3x
4548180



4x
6279875



1x
6409763



1x
6106280



2x
4644456



2x
4593678



6x
6138173



1x
6329698



4x
4538456



11x
6214807



1x
6350725



5x
6053077



1x
6166859



6x
428626



1x
4159550



2x
362326



2x
301026



1x
6138726



1x
4515350



1x
4560182



1x
6177156



3x
366626



3x
663626



1x
346026



1x
303426



1x
6252258



7x
6254552



1x
6278710



2x
6424464



1x
6247362

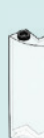

1x
6246876



1x
6386637

3x
4558595

2x
6173925

6x
4177932

3x
6411362

1x
4188771

6x
6438904

5x
4212454

5x
4183133

1x
6466199

1x
6470918

6x
6286831

1x
6092592

2x
6069006

158

4x
6185307

2x
6268818

1x
6013530

2x
4537936

1x
6395609

3x
6250075

2x
6022048

1x
6429553

3x
6274747

7x
6240550

1x
6428824

1x
4618670

2x
6274745

4x
6240553

2x
6284071

1x
6326748

3x
4211469

2x
6149677

1x
4211157

1x
4211150

3x
4558955

3x
6176400

1x
4211068

1x
6370534

1x
6466782

1x
6439231

1x
6407954



1x
6369683

5x
4517996

3x
4286050

2x
4580010

2x
6143721

1x
6348273

4x
6251940

2x
4654128

6x
4550359

2x
6253655

2x
4518890

1x
6002148

2x
6468509

4x
6106713

1x
6403189

1x
6058222

3x
6143789

1x
6453953

1x
6409759

1x
6458990

1x
6470980

1x
6466342

1x
4633691

1x
6096993

1x
6430919

3x
6102986

1x
6445843

2x
6248486

1x
6357615

2x
6060857

9x
6271374

1x
6388194

1x
6132426

1x
6468370

1x
6146494

1x
6466138

2x
6299900

1x
6416639

1x
6416546

1x
6471104

1x
6467217

2x
6325980

1x
6445346

1x
6141594

2x
6104130

1x
6022010



 [LEGO.com/service](https://www.LEGO.com/service)

YOU COULD **WIN**

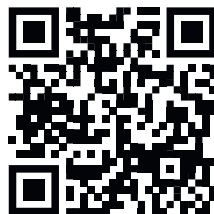

Scan this QR code or go to
LEGO.COM/PRODUCTFEEDBACK and give us
your short feedback about this LEGO® set for a
chance to win a cool LEGO prize.

Terms and Conditions apply*

EN: YOU COULD WIN. Terms and Conditions apply* **DE: Du könntest GEWINNEN.** Es gelten die Teilnahmebedingungen* **FR: Tu pourrais GAGNER.** Des conditions s'appliquent* **IT: Potresti VINCERE tu.** Termini e condizioni sono applicabili* **ES: Puedes GANAR.** Aplican términos y condiciones* **PT: Poderá GANHAR.** Aplicam-se termos e condições* **ZH: 轻松获奖. 条款和条件适用*** **PL: Szansa na WYGRANĄ.** Obowiązują warunki korzystania* **CS: Máte šanci VYHRÁT.** Platí všeobecné smluvní podmínky* **SK: Máte šancu VYHRAŤ.** Platia všeobecné zmluvné podmienky* **HU: TE IS NYERHETSZ.** Felhasználási feltételek érvényesek* **RO: Ai putea CÂȘTIGA.** Se aplică termeni și condiții* **BG: Можете да СПЕЧЕЛИТЕ.** Има определени правила и условия* **LV: Tu vari LAIMĒT.** Ir spēkā noteikumi un nosacījumi.* **ET: Sul on võimalus VÕITA.** Kehtivad tingimused* **LT: Jūs galite LAIMĖTI.** Taikomos sąlygos*

*[LEGO.com/productfeedback-terms](https://lego.com/productfeedback-terms)

LEGO, the LEGO logo and the FRIENDS logo are trademarks of the/son des marques de commerce du/son marcas registradas de LEGO Group. ©2024 The LEGO Group.

6527363